

EVOC Intelligent Branch

Shenzhen EVOC

0755-2342 1140
EVOC Technology Building 518057
No.31, Gaoxin Central Avenue 4th,
Nanshan District, Shenzhen

Guangzhou EVOC

020-8567 5197
3401, Wealth Plaza Eastern Tower
510620 ,No.116, Sports East Road,
Tianhe District, Guangzhou

Chengdu EVOC

028-8544 6878
8th Floor, Building A, East Hope
610041, No.3, Gaopeng Avenue, Hi-
Tech Industrial Development Zone,
Chengdu

Nanjing EVOC

025-8333 6188
2nd Floor, No.5 Building, Wangu
Industrial Park 210008
No.27, Yanling Lane, Nanjing

Beijing EVOC

010-8202 7878
No.7 Building, Shouhui Plaza, 100071
No.78, West 4th Ring Central Road,
Fengtai District, Beijing

Xi'an EVOC

029-8822 6888
27th Floor, Building A, EVOC City Plaza,
Xi'an, No.56, Jinye 1st Road, High Tech
Zone, Xi'an City

Shenyang EVOC

024-2398 8668
No.16, Nanping Road, Dongling
District, Shenyang (Computing
Institute) 110168

Shanghai EVOC

021-3159 9877
EVOC Technology Building 20023
Building A4, No.1528, Gumei Road,
Shanghai

Hangzhou EVOC

0571-8530 1280
EVOC Technology Building 310000
Changhe Street, Binjiang District,
Hangzhou

Qingdao EVOC

0532-6677 7057
2-425, No.2 Building, Yinhua Plaza
No.190, Shandong Road, Shibei
District, Qingdao



Parhelia B.V.
www.parheliabv.com
☎ +31(0)10 741 00 28



The pictures are for reference only, and actual appearance may differ from the pictures. This manual is subject to changes in performance indicators and other details without prior notice. The final interpretation rights of the above content belong to EVOC Intelligent Technology Co., Ltd.

研祥集团 EVOC GROUP 中国企业 研祥智能股份
SINCE 1978 500强 国产担重任, 志在最前列

Product Catalog

VOL14.0

EVOC Intelligent · Leading Provider of solutions for China's Industrial Internet Industry

PRODUCT CATALOG

VOL14.0



Top 500 Chinese Enterprises

EVOC Group has entered the Top 500 China Enterprises for many years. In 1993, it established the group's first limited liability company in Shenzhen - EVOC Intelligent Technology Co., Ltd., which is the leading supplier of industrial Internet solutions in China.

Global R&D Center

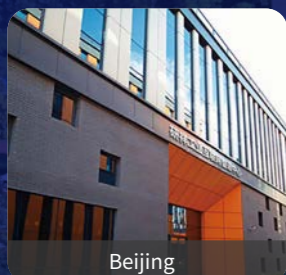

Beijing



Nanning



Hangzhou



Germany



Xi'an



Guilin



Shanghai

CONTENTS

01

About EVOC

EVOC Group: Top 500 Chinese Enterprises	002
Development History: Innovation driven development	004

02

Core Advantages

Technological Innovation: three national-level technological innovation platforms	007
Industry benchmark: a national standard for multiple industries	008
Quality assurance: the most complete laboratory system in the industry	009
System support: a fully-integrated enterprise information system	010
Famous brand: core products covering various industries	011
Self-developed products: a domestic leader in the embedded computer industry	012
Service first: providing comprehensive support and service	013

03

Product Solution

Intelligent Manufacturing	018
Rugged Information Product	098
Network Communication	124
Intelligent Platform	130

EVOC Intelligent Technology



Company Profile



EVOC Intelligent was the first limited liability company established by EVOC Group in Shenzhen in 1993, and is a leading provider of solutions for China's industrial Internet industry. Its main scope of business covers the R&D, manufacturing, and sales of embedded computer system products, industrial intelligent operating system software,

industrial cloud system platforms, and intelligent equipment. EVOC Group has 67 branches and offices worldwide, 7 R&D centers, and one European technology center. Its products are sold directly to 43 countries worldwide and indirectly to 167 countries. According to the statistics of CCID and IDG, EVOC has been ranked first in China and second in the world in terms of market share and technology leadership in the industry.

Multiple independent intellectual property rights

1300+ non-patented core technologies

National level innovative enterprise

National-level Hi-tech Enterprise

National technological innovation demonstration enterprise

67 offices worldwide

Business Coverage

EVOC's scope of business covers strategic emerging industries and key sectors such as industrial Internet, new generation information technology, artificial intelligence, Internet of Things, high-end equipment manufacturing, marine electronic information, new energy, big data, energy conservation and environmental protection. EVOC's system products are core components and key equipment for automation, intelligence, informatization, and digitization in traditional and strategic emerging industries, fully meeting the special customization needs and requirements of harsh working environments of various industries. Currently, EVOC products have been widely used in industrial internet, aerospace, artificial intelligence, high-end equipment manufacturing, emerging marine industries, new energy, electronic information, intelligent transportation, telecommunications, finance, networking, medical care, monitoring, and other major industries and fields of the national economy.

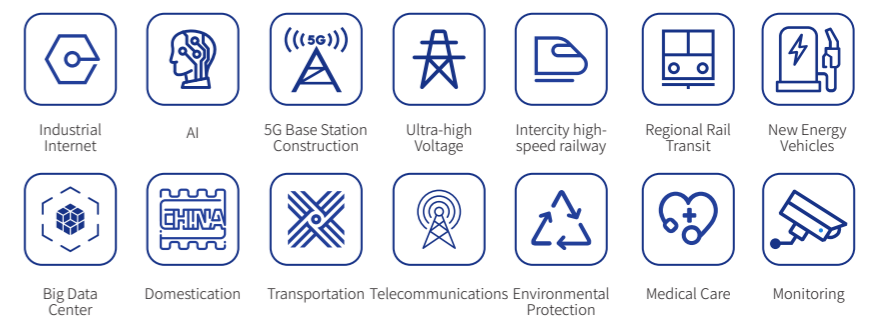

Development History

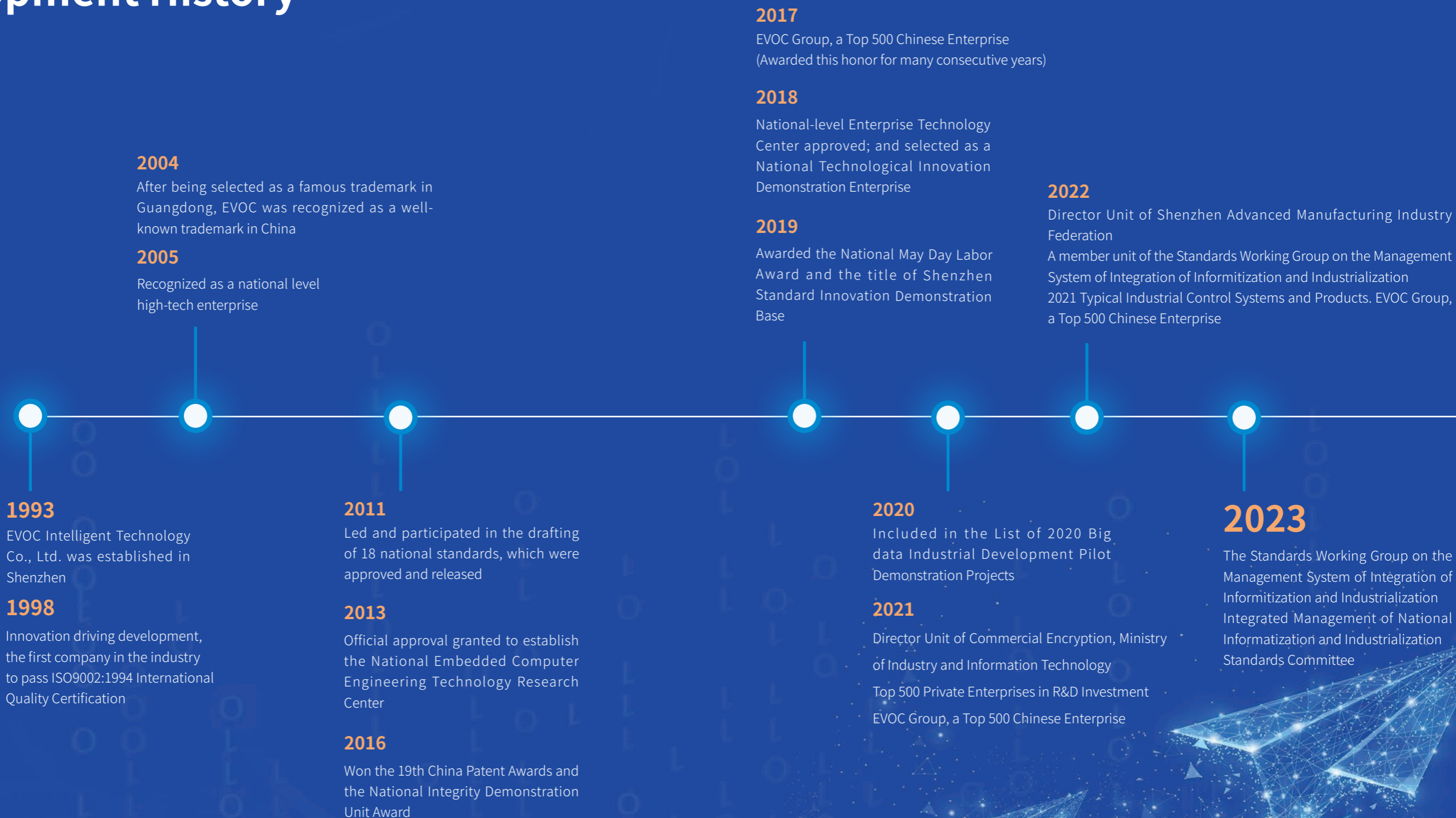

Independent Innovation



Technological Innovation

Three national-level technological innovation platforms

国家特种计算机 工程技术研究中心

中华人民共和国科学技术部

National Embedded Computer Engineering Technology Research Center

Founded in January 2013, it is a research institution specialized in embedded computer engineering technology research and engineering applications. Its construction is undertaken by EVOC Intelligent Technology Co., Ltd., jointly guided by Science and Technology Innovation Committee of Shenzhen, under the leadership of the Ministry of Science and Technology of the country.

国家地方联合 工程实验室

国家发展和改革委员会

National and Local Joint Engineering Laboratory

Founded in 2016, it is mainly aimed at research on key common technologies, such as industrial control network technology, intelligent industrial control equipment, CPS information physical system, industrial control information security, industrial big data, and industrial Internet applications, on the basis of EVOC's upstream and downstream industrial technology advantages in industrial control network and intelligent equipment technology.

国家认定 企业技术中心

国家发展改革委 科技部
财政部 海关总署 国家税务总局

National-level Enterprise Technology Center

After years of development, EVOC has continuously transformed new technological achievements into strong productivity of the company in such fields as talent aggregation and cultivation, innovation team building, key technology research, sophisticated R&D methods, and R&D equipment construction, upgraded its product and technology to the international advanced level, and become a benchmark company in the domestic industry.

Benchmark Company in the Industry

A drafter of national standards for multiple industries

Intelligent has actively led and participated in the development of international and domestic standards, and has become an example of standard innovation. Up to now, EVOC has led the drafting of all the 31 national standards in the industry, and has possessed over 1300 non-patented core technologies and other independent intellectual property rights.



Quality Assurance

The most complete laboratory system in the industry

EVOC Intelligent has built 33 laboratories with leading equipment and facilities in the industry, including safety regulation certification laboratory, embedded computer high availability technology laboratory, embedded computer compatibility and performance evaluation and testing laboratory, industrial control network technology laboratory, CAE laboratory, environment laboratory, salt fog laboratory, signal integrity laboratory, xenon lamp testing laboratory, sand-dust laboratory, and failure analysis laboratory.



System Support

A fully-integrated information system

In its production and business operation, EVOC Intelligence attaches great importance to the role of information systems in ensuring quality management. A fully-integrated information system centering on product lifecycle management, enterprise resource planning management, customer relationship management and customer management system has been established to ensure reliable quality.

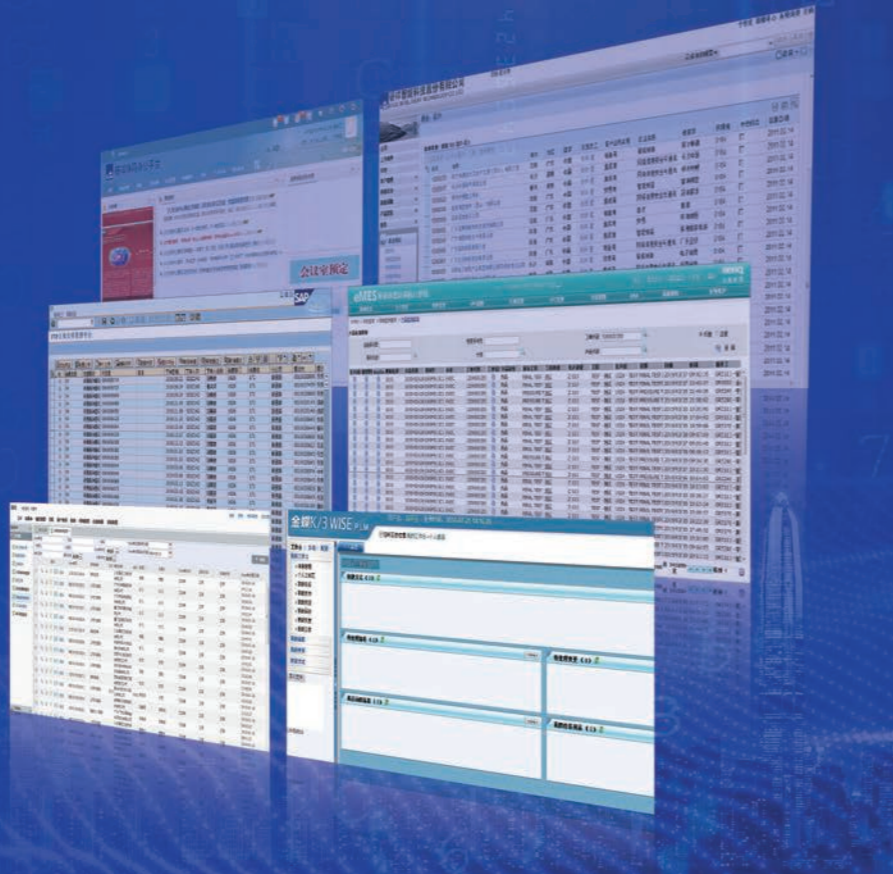

A unique reliability management system in the industry

Reliability management is implemented in the entire product lifecycle, from market demand, product planning, product R&D, design verification, production, product distribution, use, to maintenance, so as to ensure product reliability and compliance with highest quality requirements.

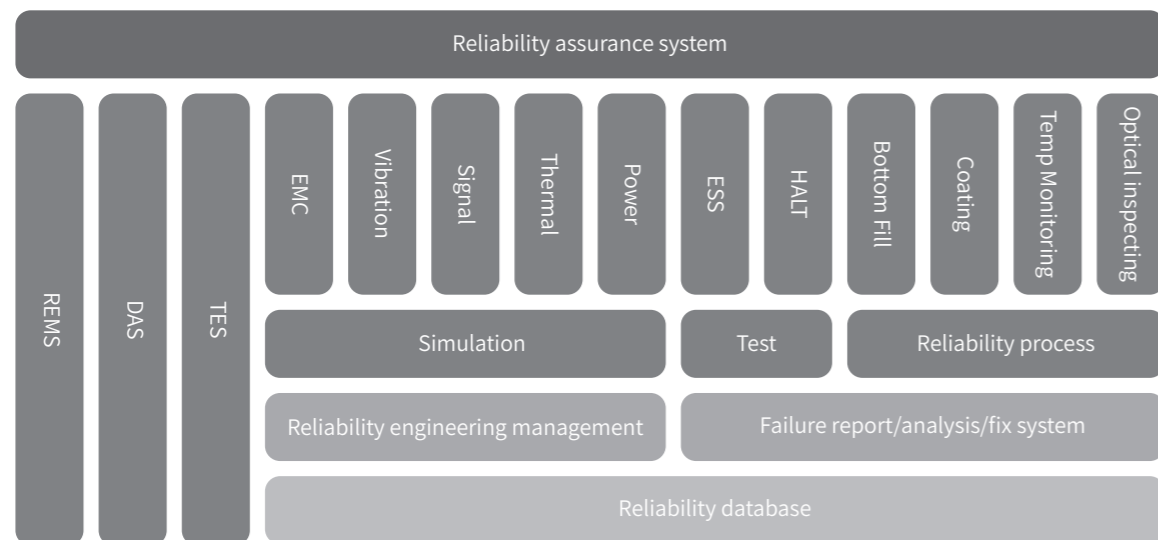

Well-known Brand

Core products covering various industries

EVOC's business covers a wide range of strategic emerging industries and key fields, such as industrial Internet, new generation information technology, artificial intelligence, Internet of Things, high-end equipment manufacturing, marine electronic information, new energy, big data, energy conservation and environmental protection. EVOC's system products serve as core components and key equipment for automation, intelligence, informatization, and digitization in traditional and strategic emerging industries, fully meeting the special customization needs and the requirements of harsh working environments of various industries. Currently, EVOC products have been widely used in major industries and fields of the national economy, including industrial Internet, aerospace, artificial intelligence, high-end equipment manufacturing, emerging marine industries, new energy, electronic information, intelligent transportation, telecommunications, finance, networking, medical care and monitoring.

Business Coverage

Widely used in...

Intelligent Manufacturing

Artificial Intelligence

Machine Vision

Rail Transit

Intelligent Medical Care

Intelligent Finance

Network Security

Aerospace

Laser Machining

New Energy

Petrochemical Industry

Domestic Production

Self-developed Products

Shoulder the responsibility of domestication of production at the forefront

<p>Domestic products for sensitive industries We provide domestic network communication series products, which are equipped with independently developed BIOS technology and security management software, for information security sensitive industries such as communication and finance.</p>	<p>Embedded computers based on domestic chips For transportation, energy, network security and other fields, we provide homegrown platforms and complete PCs based on such processors as Loongson, Phytium, Zhaoxin, Hygon, and Rockchip.</p>	<p>Targeting the field of industrial automation To meet the needs of the industrial control industry for domestic development, EVOC Intelligence provides users with economical, applicable, and cost-effective domestic substitute products and solutions. Our product series adopt domestic processors and system computing performance.</p>	<p>Homegrown-brand embedded computers All the technologies and products of EVOC have complete independent intellectual property rights, and can provide industrial grade fanless chassis, industrial grade tablet PCs, rugged computers, industry-specific complete PCs, and industrial grade motherboards for various industries.</p>
---	---	--	--

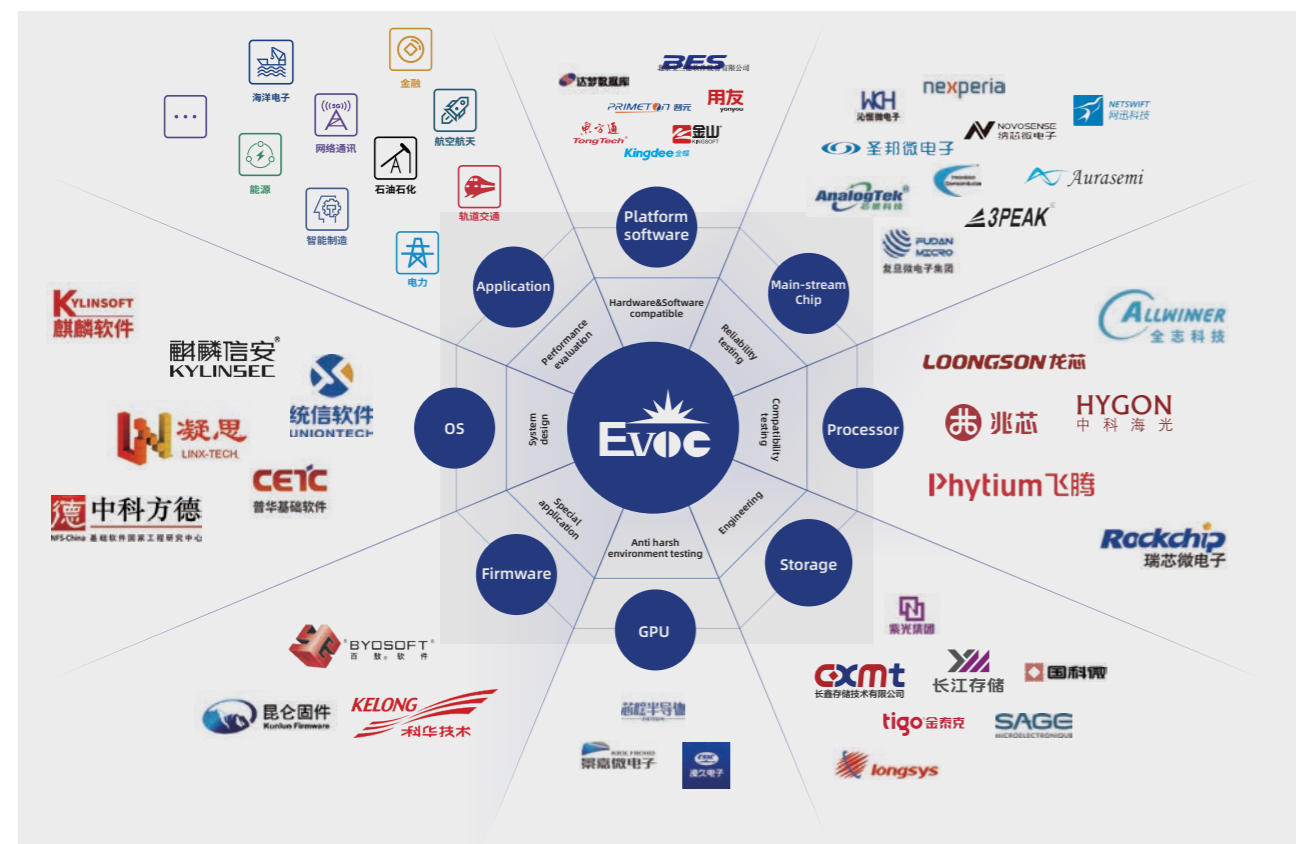

Embedded computer domestication ecological atlas

Service First

Comprehensive product support and services

EVOC Intelligence has a comprehensive global service network system and a well-trained technical service team, which can quickly respond to customer needs and feedback on a 24/7 hours basis, providing customers with personalized, all-around, and multi-channel pre-sales and in-sales service support, and reliable and considerate after-sales support.



Branches/Offices worldwide

EVOC Intelligence has set up branches and offices all over the world. Over 600 on-site experts scattered around the world can quickly respond to the needs of nearby customers or visit them in person, providing fast and effective services. We offer one-month return or exchange of our sold products, two years warranty, lifelong maintenance, nationwide warranty, and response to customer needs within 24 hours.



Official website, online support

The official website of EVOC Intelligence provides important technical documentation, a complete FAQ library, tools, and driver downloads, allowing you to directly obtain official services through online self-service.



Quick-response hotline service

You can call EVOC Intelligen's 400E hotline 400-880-9666, which features "professional answers and thoughtful services", anytime and anywhere to receive our online human services, such as product introduction, purchase consultation, and after-sales service. Any questions you feed back to us will be answered in a professional and thoughtful way.



Communication with customers on WeChat

EVOC's official WeChat platform (WeChat account: evoc1993) can keep you updated about the latest trends, industry trends, industry hot applications, and other information about EVOC Intelligence. At the same time, you can apply on the WeChat for such service items as online repair, service network inquiries and warranty period inquiries, so as to obtain professional services in a timely manner.



One-stop shopping at EVOC Mall

EVOC Intelligent's homegrown brand mall and JD/Tmall EVOC flagship store are industry-leading online channels for embedded computers. At EVOC Mall and EVOC flagship stores (JD/Tmall), you can enjoy a one-stop shopping experience by placing orders for your desired products easily with simple clicks and waiting for them delivered at your door.

PRODUCT CATALOG

Intelligent manufacturing

Edge Computing Unit

M50B	018
M60A	020
M80	022

Intelligent HMI Terminal

W15	028
W18A	030
W21	032
P12	034
P15	036
P17	038
D15	040
D17	043

Industrial control computer

IPC-520S	046
IPC-620H	048
IPC-6207	050
IPC-810E	052
IPC-820	054
IPC-860	056
MGP-800	058

Industrial motherboard

EC0-1816(F)	060
EC0-1816(E)	062
EC0-1817(B)	064
EC0-1818(C)	066
EC0-1818-C236	068
EC0-1820	070
EC0-1821	072
EC0-1822	074
EC0-1823	076
EC0-1825	078
EPE-1816	080
EPE-1815	082
EC7-1821	086
EC7-1823	088
EC3-1820	090
EC3-1821	092
COM-1817	094
COM-1818	096

Rugged PC

Portable Computer

JNB-1302P	098
JNB-1502P	100
JEC-1502	102

Rugged Computer

JPC-8203B	104
-----------	-----

Portable Tablet PC

JPD-0701	106
JPD-1003	108

Compact PCI Platform

CPC-3414B	110
CPC-8408B	112
CPC-3815B	114
CPC-3816B	116
CPC-1818	118
CPC-1819	120
CPC-1820	122

Network compliance

Industrial Network Platform

N15-01B	124
NPC-8208	126
N35-03	128

Intelligent platform

Dedicated PC

SPC-8271D	130
-----------	-----

Multiple Chipset Choice Flexible Configuration



Intel® H110/C236/BayTrail Compact Fanless PC M60A

- Stylish design**: Professional artisanal design reveals industrial
- Free choice of chipset**: Compatible with multiple chipset platform like Intel® H110/C236/BayTrail
- Flexible configuration**: Modular kit design, shortly increase/decrease the required interfaces
- wide voltage input**: Optional 9 ~ 36 VDC input
- Safe & stable**: guaranteed quality after rigorous test

Edge Computing Unit Model Selection Table

Model	M50B	M60A	M80	
Product Pictures				
System Configuration	Processor	M60A-E: Intel® Celeron J1900 2.0GHz quad-core, onboard processor which is non-replaceable; M60A-H: Intel® H110/C236: supports 6/7/8th Gen Intel® Core™ i3/i5/i7 series, and supports 9th Gen Intel® Core™ i3/i5 processors, LGA1151, CPU TDP ≤ 65W	Intel® Xeon W & 10th /11th Core™ i9/i7/i5/i3, LGA1200, processors with power consumption no more than 65W;	
	Chipset	M50B-E: Intel® BayTrail, Elkhart lake; M50B-H: Intel® Skylake-U;	M60A-E: Intel® BayTrail; M60A-H: Intel® H110/C236;	Intel® W480E;
I/O Port	LAN Port	2 x RJ45 10/100/1000Mbps LAN port, expandable up to 4 x LAN port;	Optional 2/4/6 x RJ45 10/100/1000Mbps LAN port	2 x RJ45 10/100/1000Mbps LAN port; expandable to 6 x LAN port;
	Display	Supports VGA and HDMI display ports;	"BayTrail/H110: supports any two of VGA, HDMI and DVI-D; C236: supports VGA, HDMI, DVI-D simultaneous triple independent displays;"	1 x VGA, 1 x HDMI;
Expansion Bus	USB	BayTrail: supports up to 1 x USB3.0 + 5 x USB2.0 port; Elkhart lake: supports up to 1 x USB3.0 + 5 x USB2.0 port; Skylake-U: supports up to 2 USB3.0 + 4 x USB2.0 port;"	M60A-E (BayTrail): 1 x USB3.0 + 7 x USB2.0 port M60A-H (H110): 4 x USB3.0 + 4 x USB2.0 port; M60A-H (C236): 8 x USB3.0 port;	4 x USB3.2 (Gen 2) + 4 x USB3.2 (Gen 1) port;
	COM	2/4 x COM port optional, COM1-COM4, RS232/485/422 optional;	Optional 4/5/6 x COM port, COM1-COM6 supporting RS232/485/422, and supporting up to 10 COM ports by means of an expansion box, four COM ports of the expansion box being RS-232 mode.	2 x COM port, optional RS232/485/422; 4 x built-in 2 x 5Pin Wafer pin, expandable to RS232;
Storage	Audio	Supports MIC-IN and LINE-OUT;	Supports MIC-IN, LINE-IN and LINE-OUT;	Supports MIC-IN and LINE-OUT;
	GPIO	/	1 x 8-channel GPIO (1 × 10 phoenix terminal);	/
Motherboard Integration	Others	1 x 4Pin phoenix terminal power connector;	1 x 4Pin phoenix terminal power connector;	1 x 4Pin phoenix terminal power connector;
	Hard Disk	1 x SATA interface; (optional 2.5" HDD or SSD)	Provides 2 x SATA interface; (supports 2 x 2.5" laptop hard disk)	Provides 1 x SATA interface; (supports 1 x 2.5" laptop hard disk); expandable to one or two 2.5" hard disks by means of an expansion box;
Working Environment	M-SATA/ M.2	BayTrail/ Skylake-U: supports 1 x M-SATA slot; Elkhart lake: supports 1 x M.2 KEY M and 1 x M.2 KEY B slot;	M60A-H (C236): supports 1 x M.2 keyM (PCIe X4 signal); M60A-H (H110): supports 1 x M.2 keyM (PCIe X1 signal);	Supports 1 x M-SATA slot;
	Storage Environment	0°C~+45°C (HDD); -10°C~+60°C (wide-temperature SSD/ electronic hard disk); note: The air flow rate in the working environment of the PC must be greater than 0.5m/s	Processors with different power consumption correspond to different working environment, see the product manual for details.	Processors with different power consumption correspond to different working environment, see the product manual for details.
Mounting Method	-40°C~+85°C; humidity: 5%~95% (non-condensing)	-40°C~+85°C; humidity: 5%~95% (non-condensing)	-40°C~+85°C; humidity: 5%~95% (non-condensing)	Wall mount, desktop, VESA standard arm;
Dimensions (WXHXD)	Wall mount, desktop, VESA standard arm;	Wall mount, desktop, VESA standard arm;	Wall mount, desktop;	80mm(W) × 240mm(D) × 200mm(H) M80-1P: 108mm(W) × 240mm(D) × 200mm(H) M80-2P: 129mm(W) × 240mm(D) × 200mm(H) M80-3P: 154mm(W) × 240mm(D) × 200mm(H)
Power Supply	176mm(W) × 142mm(D) × 64mm(H)	M60A-E: 240mm (W) × 185mm(D) × 58mm(H) M60A-H: 240mm(W) × 185mm(D) × 78mm(H)	Power supply by external AC 220V power adapter or DC 9-36V wide-voltage input optional;	Skylake-U: DC 19V single power supply; J1900/J6412/X6425E: DC 12V single power supply; Optional DC 9-30V wide-voltage input;

Note: The final interpretation rights for product specifications, ordering information, etc. belong to EVOC Intelligent Technology Co., Ltd.

M50B

Small-size High-performance Fanless Embedded System

M50B is a small-size, high-performance, fanless embedded product, with onboard sixth Gen Intel® Core™ i7/i5/i3 U-series processors, onboard J1900 processor+BayTrail platform chip technology solution, and onboard Intel® Celeron™ J6412/Intel® Atom™ X6425E processors, supporting operating systems such as WIN7 (64bit), WIN10, and LINUX. The complete PC has a simple structure, small size, fanless design, and excellent sealing, dust-proof, heat dissipation, and anti-vibration performance. The product is mainly used in various embedded intelligent fields such as mechanical inspection equipment, industrial automation control, and robot controller.



Product Features



Fully-sealed and fanless design



Low power and high performance

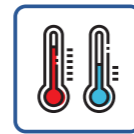

Wide-temperature operation



Multiple ports and expansibility

Product Dimensions Drawing

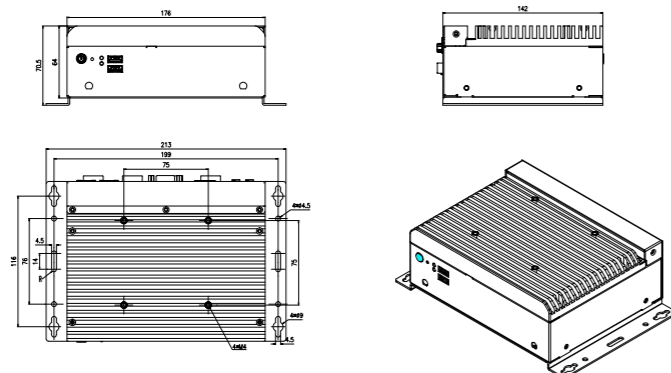

Please refer to the user manual to check detailed specifications and dimension. (Unit: MM)

Product Specifications

Item	Description	
System Configuration	Processor	M50B-E: Intel® Celeron J1900 2.0Ghz quad-core, Intel® Celeron™ J6412/ Intel® Atom™ X6425E processors, onboard processors which are non-replaceable M50B-H: supports Intel® I3-6100U/I5-6300U/I7-6600U processors, onboard processors which are non-replaceable
	Chipset	M50B-E: Intel® BayTrail, Elkhart lake; M50B-H: Intel® SkyLake-U
	Memory	BayTrail: supports 1 x SO-DIMM slot; Standard configuration 4GB, the slot supporting up to 8GB, and the PC memory supporting up to 8GB Elkhart lake: supports 1 x 260 Pin DDR4 SO-DIMM slot, the slot supporting up to 32GB, and the PC memory supporting up to 32GB; SkyLake-U: supports 1 x SO-DIMM slot; Onboard 4GB, the slot supporting up to 16GB, and the PC memory supporting up to 20GB
I/O Ports	LAN Port	2 x RJ45 10/100/1000Mbps LAN port, expandable up to four LAN ports, LAN1 supporting Wake-on-LAN
	Display	Provides 1 x VGA, 1 x HDMI display, supporting dual-display;
	USB	BayTrail: supports up to 1 x USB3.0 + 5 x USB2.0 port; Elkhart lake: standard configuration 1 x USB3.0 + 3 x USB2.0 port, supporting up to 1 x USB3.0 + 5 x USB2.0 port; SkyLake-U: supports up to 2 x USB3.0 + 4 x USB2.0 port
	COM	2~4 x COM port, COM1~COM4, RS232/485/422 optional
Expansion Bus	Motherboard Integration	1 group of Audio ports (supports MIC-IN and LINE-OUT)
		BayTrail/ SkyLake-U: 1 x M.2 key E slot (realizes WIFI function); 1 x M-SATA slot (supports 4G or storage function cannot coexist for use) Elkhart lake: 1 x M.2 key B slot (realizes 5G function or storage function); 1 x Mini-PCIE slot (realizes 4G or WiFi function); 1 x M.2 key M or PCIe4 (X2 resource) horizontal type (supports M.2 key M function by default)
Storage	Hard disk	1 x SATA interface; (optional 2.5" HDD or SSD)
	M-SATA/M.2	BayTrail/ SkyLake-U: supports 1 x M-SATA slot Elkhart lake: supports 1 x M.2 KEY M and 1 x M.2 KEY B slot;
Working Environment		0°C~+45°C (HDD); -10°C~+60°C (wide-temperature SSD/electronic hard disk) Note: The air flow rate in the working environment of the PC must be greater than 0.5m/s.
Storage Environment		-40°C~+85°C; humidity: 5%~95% (non-condensing)
Mounting Methods		Wall mount, desktop, and VESA standard arm
Product Dimensions		176mm (W) × 142mm (D) × 64mm (H) (excluding mounting bracket)
Power Supply		1 x 4Pin phoenix terminal power connector; External AC 220V power adapter power supply or DC 9-30V wide-voltage input (optional); The PC is configured with single voltage DC output by default: SkyLake-U: DC 19V single power supply; BayTrail/ Elkhart lake: DC 12V single power supply
Operating Systems		BayTrail/ SkyLake-U: supports WIN7(64bit), WIN10, LINUX(2.6 kernel) and other operating systems; Elkhart lake: WIN10, Cent OS, Linux, Ubuntu, and other high kernel version LINUX systems;

Ordering Information

Part No.	Model	Specifications
0010-165661	M50B-E-01	Micro fanless PC/ Intel® BayTrail chipset/ Celeron J1900 2.0Ghz quad-core processor/4GB memory/128G SSD/COM port*4/ USB2.0*3+USB3.0*1/Gigabit LAN port*2/VGA*1/HDMI*1/Line-out*1/MIC*1/12V DC power supply/12V power adapter*1
0020-066531	M50B-E-01	Micro fanless barebone system/ Intel® BayTrail chipset/ Celeron J1900 2.0Ghz quad-core processor/ no memory/ no hard disk/ COM port*4/ USB2.0*5+USB3.0*1/Gigabit LAN port*2/VGA*1/HDMI*1/Line-out*1/MIC*1/12V DC power supply/ no power adapter
0010-165671	M50B-E-02	Micro fanless PC/ Intel® BayTrail chipset/ Celeron J1900 2.0Ghz quad-core processor/4GB memory/128G SSD/COM port*2/ USB2.0*5+ USB3.0*1/Gigabit LAN port*4/VGA*1/HDMI*1/Line-out*1/MIC*1/12V DC power supply/12V power adapter*1
0020-066541	M50B-E-02	Micro fanless barebone system/ Intel® BayTrail chipset/ Celeron J1900 2.0Ghz quad-core processor/ no memory/ no hard disk/ COM port*2/ USB2.0*5+USB3.0*1/Gigabit LAN port*4/VGA port*1/HDMI*1/Line-out*1/MIC*1/12V DC power supply/ no power adapter
0010-177931	M50B-E-11	Micro fanless PC/ Intel Celeron J6412 2.0 GHz quad-core processor/4GB memory/128G SSD/COM port*4/ USB2.0*3+USB3.0*1/Gigabit LAN port*2/VGA*1/HDMI*1/Line-out*1/MIC*1/12V DC power supply/power adapter*1
0010-177941	M50B-E-12	Micro fanless PC/ Intel Atom X6425E 2.0 GHz quad-core processor/4GB memory/128G SSD/COM port*4/ USB2.0*3+USB3.0*1/Gigabit LAN port*2/VGA*1/ HDMI*1/Line-out*1/MIC*1/12V DC power supply/power adapter*1
0010-165681	M50B-H-01	Micro fanless PC/ Intel® Skylake SOC chipset/ I3-6100U 2.3Ghz dual-core processor/4GB memory/128G SSD/COM port*4/ USB2.0*2+USB3.0*2/Gigabit LAN port*2/VGA*1/HDMI*1/Line-out*1/MIC*1/19V DC power supply/19V power adapter*1
0020-066551	M50B-H-01	Micro fanless barebone system/ Intel® Skylake SOC chipset/ I3-6100U 2.3Ghz dual-core processor/ no memory/ no hard disk/ COM port*4/ USB2.0*2+USB3.0*2/Gigabit LAN port*2/VGA*1/HDMI*1/Line-out*1/MIC*1/19V DC power supply/ no power adapter
0010-165691	M50B-H-02	Micro fanless PC/ Intel® Skylake SOC chipset/ I5-6300U 2.4Ghz dual-core processor/4GB memory/128G SSD/COM port*4/ USB2.0*2+USB3.0*2/Gigabit LAN port*2/VGA*1/ HDMI*1/Line-out*1/MIC*1/19V DC power supply/19V power adapter*1
0020-066561	M50B-H-02	Micro fanless barebone system/ Intel® Skylake SOC chipset/ I5-6300U 2.4Ghz dual-core processor/ no memory/ no hard disk/ COM port*4/ USB2.0*2+USB3.0*2/Gigabit LAN port*2/VGA*1/HDMI*1/Line-out*1/MIC*1/19V DC power supply/ no power adapter
0010-165731	M50B-H-03	Micro fanless PC/ Intel® Skylake SOC chipset/ I7-6600U 2.6Ghz dual-core processor/4GB memory/128G SSD/COM port*2/ USB2.0*4+USB3.0*2/Gigabit LAN port*4/VGA*1/HDMI*1/Line-out*1/MIC*1/19V DC power supply/19V power adapter*1
0020-066571	M50B-H-03	Micro fanless barebone system/ Intel® Skylake SOC chipset/ I7-6600U 2.6Ghz dual-core processor/ no memory/ no hard disk/ COM port*2/ USB2.0*4+USB3.0*2/Gigabit LAN port*4/VGA*1/HDMI*1/Line-out*1/MIC*1/19V DC power supply/ no power adapter

Note: The final interpretation rights for product specifications, ordering information, etc. belong to EVOC Intelligent Technology Co., Ltd.

M60A

Low-power High-performance Fanless Embedded System

M60A is a low-power and high-performance fanless embedded product. The chassis of the product is formed by aluminum alloy die-casting. The product has a compact structure, fanless design, excellent sealing, dust-proof, heat dissipation, and anti-vibration performance, and can be used in harsh environments such as high pollution, high dust, and severe electromagnetic interference. The product is implemented using Intel C236/H110/Baytrail multiple platform technology solutions, supporting Intel® Core™ 6/7/8/9 CPU, supporting multiple gigabit LAN ports, and supporting PCI and PCIE expansion. The complete PC has complete functions and strong environmental adaptability. The product is suitable for addressing mid to high-end customer needs and can be widely used in various embedded fields such as machine vision, autonomous driving, highway lane control, mechanical testing equipment, industrial automation control, etc.



Product Features



Fully-sealed and fanless design



Low power and high performance

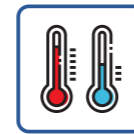

Wide-temperature operation



Multiple ports and expansibility

Product Dimensions Drawing

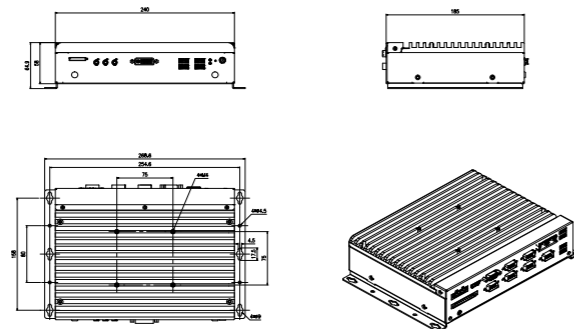

Please refer to the user manual to check detailed specifications and dimension. (Unit: MM)

Product Specifications

Item	Description	
System Configuration	Processor	M60A-E: Intel® Celeron J1900 2.0Ghz quad-core, onboard processor which is non-replaceable M60A-H: Intel® H110/C236: supports 6/7/8th Gen Intel® Core™ i3/i5/i7 series, and supports 9th Gen Intel® Core™ i3/i5 series, LGA1151, CPU TDP ≤ 65W
	Chipset	M60A-E: Intel® BayTrail M60A-H: Intel® H110/C236
	Memory	M60A-E (BayTrail): supports 1 x 204Pin DDR3L SO-DIMM slot, supporting up to 8GB M60A-H (H110/C236): supports 2 x 260Pin DDR4 SO-DIMM memory slot, single slot supporting up to 32GB, and the PC memory supporting up to 64GB
I/O Ports	LAN Ports	2/4/6 x RJ45 10/100/1000Mbps LAN port optional
	Display	M60A-E (BayTrail)/M60A-H (H110): supports any two of VGA, HDMI and DVI-D, simultaneous triple display not supported; M60A-H (C236): supports VGA, HDMI and DVI-D simultaneous triple independent displays;
	USB	M60A-E (BayTrail): 1 x USB3.0+7 x USB2.0 port; M60A-H (H110): 4 x USB3.0+4 x USB2.0 port; M60A-H (C236): 8 x USB3.0 port;
	COM	4/5/6 x COM port optional, COM1~COM6 supporting RS232/485/422 optional (MAX), and supporting 10 x COM port by means of an expansion box, four COM ports of the expansion box being RS-232 mode.
	GPIO	1 x 8-channel GPIO (1 x 10 phoenix terminal)
	Audio	1 group of Audio ports (supports MIC-IN, LINE-IN and LINE-OUT)
Expansion Bus	Motherboard Integration	1 x M-SATA slot (realizes 4G or storage function); 1 x SIM card slot, supporting external insertion of SIM card, which facilitates installation; 1 x M.2 key E slot (realizes WIFI function); M60A-H (C236) : supports 1 x M.2 keyM (PCIe X4 signal); M60A-H (H110) : supports 1 x M.2 keyM (PCIe X1 signal);
	Expansion Box	Dual expansion card 1: 2 x PCI (optional); Dual expansion card 2: 1 x PCI+1 x PCIe x16 (optional); Four expansion card 1: 4 x PCI (optional); For M60A-H (H110/C236): PCIe slot is PCIe3.0 x16 signal; For M60A-E (J1900): PCIe slot is PCIe3.0 x1 signal; Note: PCI slot supports PCI2.3 standard; PCI card supports the dimensions: 106.68mm (height) x 74.63mm (length), and PCIe card supports the dimensions: 106.68mm (height) x 167.65mm (length)
Storage	Hard Disk	Provides 2 x SATA interface, supports 2 x 2.5" laptop hard disk and supports hotswap function;
	M-SATA	Provides 1 x M-SATA slot; M60A-H (C236) : supports 1 x M.2 keyM (PCIe X4 signal); M60A-H (H110) : supports 1 x M.2 keyM (PCIe X1 signal);
Working Environment	CPU power consumption	With HDD 0°C~+45°C -10°C~+60°C
	CPU TDP<=35W	With SSD/electronic hard disk 0°C~+40°C -10°C~+60°C
	CPU TDP=35W	0°C~+40°C -10°C~+60°C
	35W<CPU TDP≤65W	0°C~+40°C -10°C~+50°C
Storage Environment	-40°C~+85°C; humidity: 5%~95% (non-condensing)	
Mounting Method	Wall mount, desktop and VESA standard arm	
Product Dimensions	Without expansion box: M60A-E: 240mm (W) × 185mm (D) × 58mm (H) ; M60A-H: 240mm (W) × 185mm (D) × 78mm (H) With expansion box: M60A-E-2P: 240mm (W) × 196.8mm(D) × 113mm (H) ; M60A-H-2P: 240mm (W) × 196.8mm(D) × 133mm (H)	
Power Supply	1 x 4Pin phoenix terminal power connector; External AC 220V power adapter power supply or DC 9-36V wide-voltage input optional; M60A-H (H110/C236) : standard configuration DC 19V single power supply (optional 9VDC-36VDC wide-voltage module) M60A-E (BayTrail): standard configuration DC 12V single power supply (optional 9VDC-36VDC wide-voltage module)	

Ordering Information

Part No.	Model	Specifications
0010-162111	M60A-E-01	Fanless PC/Intel® BayTrail chipset/Celeron J1900 2.0Ghz quad-core processor/4GB memory/128G SSD/COM port*6/USB3.0*1+USB2.0*7/Gigabit LAN port*2/VGA*1/HDMI*1/DVI*1/ GPIO*1/Line-out*1/MIC*1/ Line-in*1/12V DC power supply/12V power adapter*1
0020-066581	M60A-E-01	Fanless barebone system/Intel® BayTrail chipset/Celeron J1900 2.0Ghz quad-core processor/no memory/no hard disk/COM port*6/ USB3.0*1+ USB2.0*7/Gigabit LAN port*2/VGA*1/HDMI*1/DVI*1/ GPIO*1/Line-out*1/MIC*1/ Line-in*1/12V DC power supply/no power adapter
0010-162121	M60A-E-2P-01	Fanless PC/Intel® BayTrail chipset/Celeron J1900 2.0Ghz quad-core processor/4GB memory/128G SSD/COM port*10/USB3.0*1+USB2.0*7/Gigabit LAN port*2/VGA*1/HDMI*1/DVI*1/ GPIO*1/Line-out*1/MIC*1/ Line-in*1/PCI expansion*2/12V DC power supply/12V power adapter*1
0020-066591	M60A-E-2P-01	Fanless barebone system/Intel® BayTrail chipset/Celeron J1900 2.0Ghz quad-core processor/no memory/no hard disk/COM port*10/USB3.0*1+USB2.0*7/Gigabit LAN port*2/VGA*1/HDMI*1/DVI*1/ GPIO*1/Line-out*1/MIC*1/ Line-in*1/PCI expansion*2/12V DC power supply/no power adapter
0010-162131	M60A-H-01	Fanless PC/Intel® H110 chipset/i5-7500T 2.7Ghz quad-core processor/4GB memory/128G SSD/COM port*6/ USB3.0*4+ USB2.0*4/Gigabit LAN port*2/VGA*1/HDMI*1/DVI*1/ GPIO*1/Line-out*1/MIC*1/Line-in*1/19V DC power supply/19V power adapter*1
0020-066601	M60A-H-01	Fanless barebone system/Intel® H110 chipset/no CPU/no memory/no hard disk/COM port*6/USB3.0*4+ USB2.0*4/Gigabit LAN port*2/VGA*1/HDMI*1/DVI*1/ GPIO*1/Line-out*1/MIC*1/Line-in*1/19V DC power supply/no power adapter
0010-162141	M60A-H-2P-01	Fanless PC/Intel® H110 chipset/i5-7500T 2.7Ghz quad-core processor/4GB memory/128G SSD/COM port*10/USB3.0*4+ USB2.0*4/Gigabit LAN port*2/VGA*1/HDMI*1/DVI*1/ GPIO*1/Line-out*1/MIC*1/Line-in*1/PCI+PCIE*1 expansion/19V DC power supply/ 19V power adapter*1
0020-066611	M60A-H-2P-01	Fanless barebone system/Intel® H110 chipset/no CPU/no memory/no hard disk/COM port*10/ USB3.0*4+ USB2.0*4/Gigabit LAN port*2/VGA*1/HDMI*1/DVI*1/ GPIO*1/Line-out*1/MIC*1/Line-in*1/ PCI*1+PCIE*1 expansion/19V DC power supply/no power adapter
0010-162151	M60A-H-21	Fanless PC/Intel® C236 chipset/i7-8700 3.2Ghz six-core processor/4GB memory/128G SSD/COM port*5/USB3.0*8/Gigabit LAN port*4/VGA*1/HDMI*1/DVI*1/ GPIO*1/Line-out*1/MIC*1/ Line-in*1/19V DC power supply/ 19V power adapter*1
0020-066621	M60A-H-21	Fanless barebone system/Intel® C236 chipset/no CPU/no memory/no hard disk/COM port*5/USB3.0*8/Gigabit LAN port*4/VGA*1/HDMI*1/DVI*1/ GPIO*1/Line-out*1/MIC*1/ Line-in*1/19V DC power supply/no power adapter

Note: The final interpretation rights for product specifications, ordering information, etc. belong to EVOC Intelligent Technology Co., Ltd.

M80

High-performance Embedded System

M80 is a high-performance embedded platform with an Intel W480E chipset on the motherboard, supporting the 10th/11th Gen Xeon® Core™ processors. The PC has a simple structure, small form factor, excellent heat dissipation and anti-vibration performance. The PC has multiple IO ports and supports both WIFI and 4G functions. Multiple IO ports can be expanded by means of high-speed connectors, and can be self-defined by users. The PC supports PCI and PCIE expansions to meet different application needs. The product is mainly used in machine vision, highway lane controller, AI and edge computing, vehicle infrastructure cooperative System and assisted driving, intelligent manufacturing of non-standard equipment and other application fields.



Product Features



Fully-sealed and fanless design



Supports 4G and WIFI modules



Excellent heat dissipation and anti-vibration performance



High performance

Product Dimensions Drawing

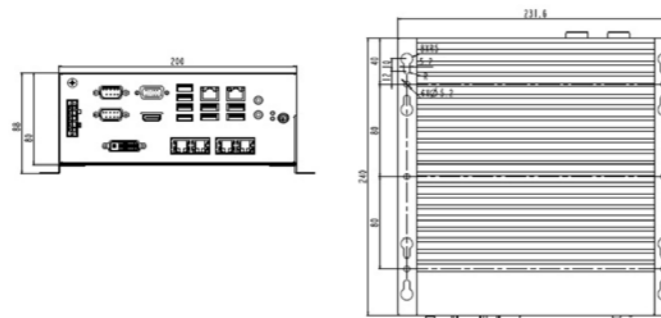

Please refer to the user manual to check detailed specifications and dimension. (Unit: MM)

Product Specifications



Item	Description	
System Configuration	Processor	Intel® Xeon W & 10th /11th Core™ i9/i7/i5/i3, LGA1200, processors with power consumption no more than 65W;
	Chipset	Intel® W480E
	Memory	2 x 260 Pin DDR4 SO-DIMM slot, a single slot supporting up to 32G, and the PC supporting up to 64G;
I/O Ports	External Ports on the PC	2 x RJ45 10/100/1000Mbps LAN port, expandable to 6 x LAN port; 4 x USB3.2 (Gen 2) +4 x USB3.2 (Gen 1) port; 2 x COM port (RS232/485/422 optional); 1 group of Audio ports (supports MIC-IN and LINE-OUT); 1 x VGA, 1 x HDMI display, internal 1 x DVI port;
	Internal Ports on the Motherboard	1 x 8-channel GPIO; 4 x built-in 2x5Pin Wafer pin (expandable to RS232); 1 x built-in USB2.0 (1x5PIN wafer pin, supporting expansion to built-in dongle by means of USB cable); 4 x SATA 3.0 (6Gbps), supporting Raid 0/1/5/10; 1 x TPM port, supporting TPM2.0;
Expansion Bus	Motherboard Integration	1 x M-SATA slot (realizes 4G or storage function, 4G function and storage expansion cannot coexist for use); 1 x internal SIM card slot; 1 x M.2 Key E (can realize WIFI expansion); 1 x 2 x 30Pin high speed connector, self-defined expansion port, supporting external connection to an expansion module;
		Storage
	MSATA/M.2	Supports 1 x M-SATA slot;
Remote Maintenance		Supports AMT function;
Power Supply		1 x 4Pin phoenix terminal power connector; External AC 220V power adapter or DC 9-36V wide-voltage input optional;
Switch Indicator		Power supply, hard disk indicator lights
Environment Requirements	Working Temperature	0°C~+45°C (HDD/normal temperature SSD); -20°C~+60°C (wide-temperature SSD/electronic hard disk, CPU TDP≤35W) -20°C~+50°C (wide-temperature SSD/electronic hard disk, 35W<CPU TDP≤35W) Notes: 1.For fanless PC, HDD common mechanical hard disk is not recommended, and the air flow rate in the working environment of the PC must be greater than 0.7m/s. 2.For the configuration with fan, HDD mechanical hard disk can be used.
	Storage Temperature	-40°C~+85°C; humidity: 5%~95% (non-condensing)
Mounting Method		Wall mount, desktop;
Dimensions		80mm (W) × 240mm (D) × 200mm (H) M80-1P: 108mm (W) × 240mm (D) × 200mm (H) M80-2P: 129mm (W) × 240mm (D) × 200mm (H) M80-3P: 154mm (W) × 240mm (D) × 200mm (H)
Operating System		Supports WIN10 (64 bit), Server 2019 and Ubuntu X64, Cent OS and other high kernel version Linux operating systems;

Ordering Information

Part No.	Description	Specifications
0010-169421	M80-01	Fanless computing unit/Intel® W480E chipset/i5-10500 3.1Ghz six-core processor/8G memory/128G SSD/COM port*2/USB3.2 (Gen 2) *4+ USB3.2 (Gen 1) *4/Gigabit LAN port*2/VGA*1/HDMI*1/Line-out*1/MIC*1/9~36V DC power supply/19V adapter*1
0020-066141	M80-01	Fanless barebone system/Intel® W480E chipset/no CPU/no memory/no hard disk/COM port*2/USB3.2 (Gen 2) *4+USB3.2 (Gen 1) *4/Gigabit LAN port*2/VGA*1/HDMI*1/Line-out*1/MIC*1/9~36V DC power supply/no adapter
0010-171991	M80-1P-01	Expandable computing unit/Intel® W480E chipset/i3-10100 3.6Ghz quad-core processor/8G memory/128G SSD/COM port*4/USB3.2 (Gen 2) *4+ USB3.2 (Gen 1) *4/Gigabit LAN port*2/VGA*1/HDMI*1/Line-out*1/MIC*1/PCIEx16*1/9~36V DC power supply/19V adapter*1
0010-172001	M80-2P-01	Expandable computing unit/Intel® W480E chipset/i5-10500 3.1Ghz six-core processor/8G memory/128G SSD/COM port*4/USB3.2 (Gen 2) *4+ USB3.2 (Gen 1) *4/Gigabit LAN port*4/VGA*1/HDMI*1/Line-out*1/MIC*1/PCIEx16*1/9~36V DC power supply/19V adapter*1
0010-172011	M80-2P-02	Expandable computing unit/Intel® W480E chipset/i5-11500 2.7Ghz six-core processor/8G memory/128G SSD/COM port*4/USB3.2 (Gen 2) *4+ USB3.2 (Gen 1) *4/Gigabit LAN port*2/VGA*1/HDMI*1/Line-out*1/MIC*1/PCIEx16*1/PCIEx4*1/9~36V DC power supply/19V adapter*1
0010-172021	M80-3P-01	Expandable computing unit/Intel® W480E chipset/i7-11700 2.5Ghz eight-core processor/8G memory/128G SSD/COM port*4/USB3.2 (Gen 2) *4+ USB3.2 (Gen 1) *4/Gigabit LAN port*6/VGA*1/HDMI*1/Line-out*1/MIC*1/PCIEx16*1/PCI*2/9~36V DC power supply/19V adapter*1



Note: The final interpretation rights for product specifications, ordering information, etc. belong to EVOC Intelligent Technology Co., Ltd.

Intelligent HMI Terminal Model Selection Table

Model		W15	W18A	W21
Product Picture				
Display Function	Display Size	15.6" TFT LCD 16:9;	19" TFT LCD 16:10;	21.5" TFT LCD 16:9;
	Maximum Resolution	1920x1080 ;	1440x900 ;	1920x1080 ;
	Brightness	250cd/m ²	250cd/m ² ;	250cd/m ²
	Contrast Ratio	800:1 ;	1000:1 ;	1000:1 ;
Touch Screen		Capacitive touch screen, multi-touch;	Capacitive touch screen, multi-touch;	Capacitive touch screen, multi-touch;
System Configuration	Processor	Intel® Celeron J1900; SkyLake-U: onboard Intel® I3-6100U/I5-6300U/ I7-6600U processors; H110/C236: supports 6/7/8th Gen Intel® Core™ I3/I5/I7 series processors, and supports 9th Gen Intel® Core™ I3/I5 series processors, LGA1151, CPU TDP ≤ 65W; H310/Q370: supports 8/9th Gen Intel® Core™ I3/I5/I7 series processors, Cleron, Pentium series processors, LGA1151, CPU TDP ≤ 65W;	Intel® Celeron J1900; SkyLake-U: onboard Intel® I3-6100U/I5-6300U/ I7-6600U processor; H110/C236: supports 6/7/8th Gen Intel® Core™ I3/I5/I7 series processors, and supports 9th Gen Intel® Core™ I3/I5 series processors, LGA1151, CPU TDP ≤ 65W; H310/Q370: supports 8/9th Gen Intel® Core™ I3/I5/I7 series processors, Cleron, Pentium series processors, LGA1151, CPU TDP ≤ 65W;	Intel® Celeron J1900; SkyLake-U: onboard Intel® I3-6100U/I5-6300U/ I7-6600U processors; H110/C236: supports 6/7/8th Gen Intel® Core™ I3/I5/I7 series processors, and supports 9th Gen Intel® Core™ I3/I5 series processors, LGA1151, CPU TDP ≤ 65W; H310/Q370: supports 8/9th Gen Intel® Core™ I3/I5/I7 series, Cleron, Pentium series processors, LGA1151, CPU TDP ≤ 65W;
	Chipset	Intel®BayTrail/SkyLake-U/H110/C236/H310/Q370		
	Memory	BayTrail: supports 1 x 204Pin DDR3L SO-DIMM slot, supporting up to 8GB; SkyLake-U: supports 1 x 260Pin DDR4 SO-DIMM memory slot, onboard 4GB, the slot supporting up to 16GB and the PC memory supporting up to 20GB; H110/C236/H310/Q370: supports 2 x 260Pin DDR4 SO-DIMM memory slot, single slot supporting up to 32GB and the PC memory supporting up to 64GB;	BayTrail: supports 1 x 204Pin DDR3L SO-DIMM slot, supporting up to 8GB; SkyLake-U: supports 1 x 260Pin DDR4 SO-DIMM memory slot, onboard 4GB, the slot supporting up to 16GB and the PC memory supporting up to 20GB; H110/C236/H310/Q370: supports 2 x 260Pin DDR4 SO-DIMM memory slot, single slot supporting up to 32GB and the PC memory supporting up to 64GB;	BayTrail: supports 1 x 204Pin DDR3L SO-DIMM slot, supporting up to 8GB; SkyLake-U: supports 1 x 260Pin DDR4 SO-DIMM memory slot, onboard 4GB, the slot supporting up to 16GB and the PC memory supporting up to 20GB; H110/C236/H310/Q370: supports 2 x 260Pin DDR4 SO-DIMM memory slot, single slot supporting up to 32GB and the PC memory supporting up to 64GB;
I/O Ports	LAN Ports	Optional 2/4/6 x RJ45 10/100/1000Mbps LAN port;		
	Display	BayTrail/SkyLake-U: supports VGA and HDMI display ports; H110/C236/H310/Q370: supports VGA, HDMI and DVI display ports;		
	USB	4-8 x USB port (depending on specific configurations);		
	COM	2~6 x COM port; (depending on specific configurations)		
	Audio	1 group of Audio ports; (depending on specific configurations)		
	GPIO	Depends on specific configurations;		
	Others	1 x 4Pin phoenix terminal power connector;		
	Expansion Slot	The expansion slot depends on specific configurations;		
Storage	Hard Disk	Supports 1~2 x 2.5" hard disk (depending on specific configurations)		
	M-SATA/M.2	BayTrail/SkyLake-U: 1 x M-SATA slot; H110/C236: 1 x M-SATA slot, 1 x M.2 keyM slot; H310: 1 x M.2 keyB slot; Q370: 1 x M.2 keyM slot;		
Working Environment				
Processors of different consumptions correspond to different working environments. See Product Manual for details.				
Storage Environment		-30°C~+65°C; humidity: 5%~95% (non-condensing)	-20°C~+60°C; humidity: 5%~95% (non-condensing)	-30°C~+65°C; humidity: 5%~95% (non-condensing)
Mounting Method		Embedded type, VESA standard arm;		
Product Dimensions		407mm (W) x259.3mm(H) (depth depending on specific configurations)	480mm (W) x330mm(H) (depth depending on specific configurations)	555mm (W) x347mm(H) (depth depending on specific configurations)
Mounting Hole Dimensions		384mm (W) x236mm(H)	469mm (W) x319mm(H)	521mm (W) x313mm(H)
Power Supply		1 x 4Pin phoenix terminal power connector, input voltage depending on specific configurations;		



Note: The final interpretation rights for product specifications, ordering information, etc. belong to EVOC Intelligent Technology Co., Ltd.

Intelligent HMI Terminal Model Selection Table

Model		P12	P15	P17
Product Picture				
Display Function	Display Size	12" TFT LCD 4:3;	15" TFT LCD 4:3;	17" TFT LCD 5:4;
	Maximum Resolution	1024x768 ;	1024x768 ;	1280x1024 ;
	Brightness	350cd/m ² ;	300cd/m ² ;	250cd/m ² ;
	Contrast Ratio	800:1 ;	600:1 ;	1000:1 ;
Touch Screen		5-wire resistive touch screen, single-touch;	5-wire resistive touch screen, single-touch;	5-wire resistive touch screen, single-touch;
System Configuration	Processor	Intel® Celeron J1900; SkyLake-U: onboard Intel® I3-6100U/I5-6300U/ I7-6600U processors; H110/C236: supports 6/7/8th Gen Intel® Core™ I3/I5/I7 series processors, and supports 9th Gen Intel® Core™ I3/I5 series, LGA1151, CPU TDP ≤ 65W; H310/Q370: supports 8/9th Gen Intel® Core™ I3/I5/I7 series processors, Cleron, Pentium series processors, LGA1151, CPU TDP ≤ 65W;	Intel® Celeron J1900; SkyLake-U: onboard Intel® I3-6100U/I5-6300U/ I7-6600U processors; H110/C236: supports 6/7/8th Gen Intel® Core™ I3/I5/I7 series processors, and supports 9th Gen Intel® Core™ I3/I5 series processors, LGA1151, CPU TDP ≤ 65W; H310/Q370: supports 8/9th Gen Intel® Core™ I3/I5/I7 series processors, Cleron, Pentium series processors, LGA1151, CPU TDP ≤ 65W;	Intel® Celeron J1900; SkyLake-U: onboard Intel® I3-6100U/I5-6300U/ I7-6600U processors; H110/C236: supports 6/7/8th Gen Intel® Core™ I3/I5/I7 series processors, and supports 9th Gen Intel® Core™ I3/I5 series processors, LGA1151, CPU TDP ≤ 65W; H310/Q370: supports 8/9th Gen Intel® Core™ I3/I5/I7 series processors, Cleron, Pentium series processors, LGA1151, CPU TDP ≤ 65W;
	Chipset	Intel®BayTrail/SkyLake-U/H110/C236/H310/Q370		
	Memory	BayTrail: supports 1 x 204Pin DDR3L SO-DIMM slot, supporting up to 8GB; SkyLake-U: supports 1 x 260Pin DDR4 SO-DIMM memory slot, onboard 4GB, the slot supporting up to 16GB and the PC memory supporting up to 20GB; H110/C236/H310/Q370: supports 2 x 260Pin DDR4 SO-DIMM memory slot, single slot supporting up to 32GB and the PC memory supporting up to 64GB;	BayTrail: supports 1 x 204Pin DDR3L SO-DIMM slot, supporting up to 8GB; SkyLake-U: supports 1 x 260Pin DDR4 SO-DIMM memory slot, onboard 4GB, the slot supporting up to 16GB and the PC memory supporting up to 20GB; H110/C236/H310/Q370: supports 2 x 260Pin DDR4 SO-DIMM memory slot, single slot supporting up to 32GB and the PC memory supporting up to 64GB;	BayTrail: supports 1 x 204Pin DDR3L SO-DIMM slot, supporting up to 8GB; SkyLake-U: supports 1 x 260Pin DDR4 SO-DIMM memory slot, onboard 4GB, the slot supporting up to 16GB and the PC memory supporting up to 20GB; H110/C236/H310/Q370: supports 2 x 260Pin DDR4 SO-DIMM memory slot, single slot supporting up to 32GB and the PC memory supporting up to 64GB;
I/O Ports	LAN Ports	Optional 2/4/6 x RJ45 10/100/1000Mbps LAN port;		
	Display	BayTrail/SkyLake-U: supports VGA and HDMI display ports; H110/C236/H310/Q370: supports VGA, HDMI and DVI display ports;		
	USB	4-8 x USB port (depending on specific configurations);		
	COM	2~6 x COM port; (depending on specific configurations)		
	Audio	1 group of Audio ports; (depending on specific configurations)		
	GPIO	Depends on specific configurations;		
	Others	1 x 4Pin phoenix terminal power connector;		
	Expansion Slot	The expansion slot depends on specific configurations;		
Storage	Hard Disk	Supports 1~2 x 2.5" hard disk (depending on specific configurations)		
	M-SATA/M.2	BayTrail/SkyLake-U: 1 x M-SATA slot; H110/C236: 1 x M-SATA slot, 1 x M.2 keyM slot; H310: 1 x M.2 keyB slot; Q370: 1 x M.2 keyM slot;		
Working Environment				
Processors of different consumptions correspond to different working environments. See Product Manual for details.				
Storage Environment		-20°C~+60°C; humidity: 5%~95% (non-condensing)		
Mounting Method		Embedded type, VESA standard arm;		
Product Dimensions		303mm (W) x251mm(H) (depth depending on specific configurations)	374.5mm (W) x298mm(H) (depth depending on specific configurations)	421.5mm (W) x357mm(H) (depth depending on specific configurations)
Mounting Hole Dimensions		290.6mm (W) x238.6mm(H)	350.5mm (W) x274mm(H)	386.6mm (W) x323.6mm(H)
Power Supply		1 x 4Pin phoenix terminal power connector, input voltage depending on specific configurations;		

Note: The final interpretation rights for product specifications, ordering information, etc. belong to EVOC Intelligent Technology Co., Ltd.

Intelligent HMI Terminal Model Selection Table

Model		D15	D17
Product Picture			
Display Performance	Display Size	15" 4:3 square screen	17" 5:4 square screen
	Maximum Resolution	1024x768	1280x1024
	Brightness	300cd/m ² ;	250cd/m ² ;
	Contrast Ratio	600:1	1000:1
Touch Screen		Full-plane 5-wire resistance (USB signal)	Full-plane 5-wire resistance (USB signal)
Display Function		Supports three standard port input: VGA, HDMI, DVI	Supports three standard port input: VGA, HDMI, DVI
External I/O Ports		1 x Type-B USB2.0 input port (used for touch screen) 1 x VGA input port 1 x HDMI input port 1 x DVI input port 1 x LINE IN input port	1 x Type-B USB2.0 input port (used for touch screen) 1 x VGA input port 1 x HDMI input port 1 x DVI input port 1 x LINE IN input port
Speaker		2 x 8Ω 3W speaker	2 x 8Ω 3W speaker
OSD Menu		Brightness, contrast ratio, automatic correction, function settings, reset, etc.	Brightness, contrast ratio, automatic correction, function settings, reset, etc.
Mechanical Environmental Adaptability		Anti-vibration performance in working: frequency 5-15Hz, amplitude 1mm; frequency 15-200Hz, acceleration 1.0g Shock: 15g acceleration, 11ms duration	Anti-vibration performance in working: frequency 5-15Hz, amplitude 1mm; frequency 15-200Hz, acceleration 1.0g Shock: 15g acceleration, 11ms duration
Safety		Meets basic requirements of GB4943-2011	Meets basic requirements of GB4943-2011
Reliability		MTBF≥50000h MTTR≤0.5h	MTBF≥50000h MTTR≤0.5h
EMC		GB 9254-2021 radiated emission class (A) GB 9254-2021 conducted emission class (A) GB/T 17626.2-2018 electrostatic discharge level (2); GB/T 17626.4-2018 burst immunity level (2) GB/T 17626.5-2019 surge (shock) immunity level (2) GB/T 17626.6-2017 conducted immunity level (2)	GB 9254-2021 radiated emission class (A) GB 9254-2021 conducted emission class (A) GB/T 17626.2-2018 electrostatic discharge level (2); GB/T 17626.4-2018 burst immunity level (2) GB/T 17626.5-2019 surge (shock) immunity level (2) GB/T 17626.6-2017 conducted immunity level (2)
Operating Environment		-5°C ~ +55°C	-5°C ~ +55°C
Storage Environment		-20°C ~ +65°C	-20°C ~ +65°C
IP Grade		The front panel meets IP65	The front panel meets IP65
Product Dimensions		374.5mm (width) × 298mm (height) × 55.8mm (depth)	411.5mm (width) × 351mm (height) × 55.8mm (depth)
Mounting Dimensions		350.5mm (width) × 274mm (height)	386.6mm (width) × 323.6mm (height)
Power Supply		Input voltage/frequency: 220VAC/50Hz (with adapter) Input voltage: 12VDC (no adapter, direct input of the PC)	Input voltage/frequency: 220VAC/50Hz (with adapter) Input voltage: 12VDC (no adapter, direct input of the PC)

Note: The final interpretation rights for product specifications, ordering information, etc. belong to EVOC Intelligent Technology Co., Ltd.

Low power consumption wide temperature & voltage stable operation



15.6" Embedded Industrial Panel PC

W15

Industrial grade touch screen

15.6" industrial grade touch screen, support 10 points touch control

Water-proof & dust-proof panel

Front panel supports IP65 protection level

Full metal design

aluminum alloy frame design, full metal frame, compact design

Flexible configuration

modular design, can choose different PC based on different application

Safe & stable,

guaranteed quality after tough test

W15

15.6" Wide-screen Industrial Panel PC

W15 series is a 15.6" wide-screen industrial panel PC, featuring multi-touch, and effective integration of high reliability and industrial aesthetics, which interprets the excellent texture and technology fashion elements of industrial PC in terms of industrial design and leads the intelligent upgrading of the industry. The product supports multiple platforms, such as Intel H110/H310/Q370/C236, Intel Skylake-U SOC, Intel Bay Trail, etc., and supports Windows 7 (64bit), Windows 10, LINUX(2.6 kernel) and other operating systems. This series targets high-end MES, comprehensive monitoring, automation and other fields, and mainly used in harsh industrial on-site control applications, such as production line MES, comprehensive monitoring (rail transit, buildings, power, etc.), medical informatization, single crystal furnace machines, and wind power.



Product Features



Fashionable appearance, ruggedness and durability

Multiple ports and expansibility

Industrial-grade touch screen

Touch buttons

Fully-sealed and fanless design

Protection grade IP65

Multiple mounting methods

Product Dimensions Drawing

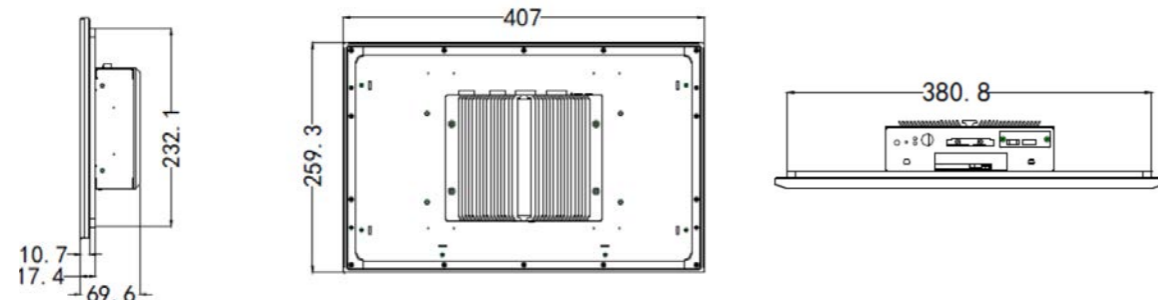

Please refer to the user manual to check detailed specifications and dimension. (Unit: MM)

Product Specifications

Item		Description		
Display Performance	Screen Size	15.6" TFT LCD 16:9;	Brightness	250cd/m ²
	Maximum Resolution	1920*1080	Contrast Ratio	800:1
Touch Screen		Capacitive touch screen, multi-touch;		
System Configuration	Processor	Intel® Celeron J1900 2.0Ghz quad-core, onboard processor which is non-replaceable; SkyLake-U: onboard Intel® I3-6100U/I5-6300U/I7-6600U processors; H110/C236: supports 6/7/8th Gen Intel® Core™ I3/I5/I7 series processors, and supports 9th Gen Intel® Core™ I3/I5 series processors, LGA1151, CPU TDP ≤ 65W; H310/Q370: supports 8/9th Gen Intel® Core™ I3/I5/I7 series processors, Cleron, Pentium series processors, LGA1151, CPU TDP ≤ 65W;		
	Chipset	Intel® BayTrail; SkyLake-U; H110/C236; H310/Q370;		
	Memory	BayTrail: supports 1 x 204Pin DDR3L SO-DIMM slot, supporting up to 8GB; SkyLake-U: supports 1 x 260Pin DDR4 SO-DIMM memory slot, onboard 4GB, the slot supporting up to 16GB and the PC supporting up to 20GB; H110/C236/H310/Q370: supports 2 x 260Pin DDR4 SO-DIMM memory slot, single slot supporting up to 32GB and the PC supporting up to 64GB;		
I/O Ports	LAN Port	Optional 2/4/6 x RJ45 10/100/1000Mbps LAN port;		
	Display	BayTrail/ SkyLake-U: supports VGA and HDMI display ports; H110/C236/H310/Q370: supports VGA, HDMI and DVI display ports;		
	USB	BayTrail: 1 x USB3.0+5 x USB2.0 port; SkyLake-U: 2 x USB3.0+2 x USB2.0 port; H110: 4 x USB3.0+4 x USB2.0 port; C236: 8 x USB3.0; H310/Q370: 4 x USB3.0+4 x USB2.0 port;		
	COM	2-6 x COM port; (depending on specific configurations)		
	Audio	BayTrail/SkyLake-U: 1 group of Audio ports (supporting MIC-IN and LINE-OUT); H110/C236/H310/Q370: 1 group of Audio ports (supporting MIC-IN, LINE-OUT and LINE-IN);		
Storage	Expansion Slot	The expansion slot depends on specific configurations;		
	Hard Disk	BayTrail/SkyLake-U: 1 x SATA; H110/C236/H310/Q370: 2 x SATA; BayTrail/SkyLake-U: 1 x M-SATA slot; H110/C236: 1 x M-SATA slot, 1 x M.2 keyM slot; H310: 1 x M.2 keyB slot; Q370: 1 x M.2 keyM slot;		
Working Environment	CPU power consumption	With HDD	With SSD/electronic hard disk	
	CPU TDP < 35W	0°C~+45°C	0°C~+50°C	
	35W ≤ CPU TDP ≤ 65W	0°C~+40°C	0°C~+50°C	
Storage Environment	Note: the air flow rate in the working environment of the PC depends on specific configurations;			
Dimensions	-30°C~+65°C; humidity: 5%~95% (non-condensing)			
Mounting Dimensions	407mm (W) x259.3mm(H)(depth depending on specific configurations)			
Material of Front Panel	384mm (W) x236mm(H)			
Mounting Method	High strength aluminum alloy panel, and the front panel meets IP65 grade;			
Power Supply	Embedded type, VESA standard arm;			
	1 x 4Pin phoenix terminal power connector, input voltage depending on specific configurations;			

Ordering Information

Part No.	Description	Specifications
0010-115441	W15-01	15.6" panel PC/Intel®BayTrail chipset/Celeron J1900 2.0Ghz quad-core processor/4GB memory/500G hard disk/COM port*4/USB port*4/Gigabit LAN port*2/VGA*1/HDMI*1/DVI*1/PS/2*1/Line-out*1/MIC*1/9~30V DC power supply/power adapter/Al-alloy front panel/capacitive touch screen
0010-115451	W15-31	15.6" panel PC/Intel®Skylake SOC chipset/I3-6100U 2.3Ghz dual-core processor/4GB memory/500G hard disk/COM port*4/USB port*4/Gigabit LAN port*2/VGA*1/HDMI*1/PS/2*1/Line-out*1/Mic-in*1/9~30V DC power supply/power adapter/Al-alloy front panel/capacitive touch screen
0010-115461	W15-32	15.6" panel PC/Intel®Skylake SOC chipset/I5-6300U 2.4Ghz dual-core processor/4GB memory/500G hard disk/COM port*4/USB port*4/Gigabit LAN port*2/VGA*1/HDMI*1/PS/2*1/Line-out*1/Mic-in*1/9~30V DC power supply/power adapter/Al-alloy front panel/capacitive touch screen
0010-114001	W15-51	15.6" panel PC/Intel®H110 chipset/I3-6100T 2.7Ghz dual-core processor/4GB memory/500G hard disk/COM port*6/USB port*8/Gigabit LAN port*2/VGA*1/HDMI*1/DVI*1/PS/2*1/Line-out*1/MIC*1/Line-in*1/9~36V DC power supply/power adapter/Al-alloy front panel
0010-174621	W15-61	15.6" panel PC/Intel®BayTrail chipset/Celeron J1900 2.0Ghz quad-core processor/4GB memory/128G SSD/COM port*2/USB2.0 *5+ USB3.0 *1/Gigabit LAN port*4/VGA *1/HDMI*1/Line-out*1/MIC*1/12V DC power supply/12V power adapter*1/Al-alloy front panel/capacitive touch screen
0010-174631	W15-62	15.6" panel PC/Intel Skylake SOC chipset/I3-6100U 2.3Ghz dual-core processor/4GB memory/128G SSD/COM port*4/USB2.0 *2+USB3.0 *2 /Gigabit LAN port*2/VGA *1/HDMI*1/Line-out*1 /MIC*1/19V DC power supply/19V power adapter*1/Al-alloy front panel/capacitive touch screen
0010-174641	W15-63	15.6" panel PC/Intel®Skylake SOC chipset/I5-6300U 2.4Ghz dual-core processor/8GB memory/128G SSD/COM port*4/USB2.0 *2+USB3.0 *2/Gigabit LAN port*2/VGA *1/HDMI*1/Line-out*1/MIC*1/19V DC power supply/19V power adapter*1/Al-alloy front panel/capacitive touch screen
0010-174651	W15-64	15.6" panel PC/Intel®Skylake SOC chipset/I7-6600U 2.6Ghz dual-core processor/8GB memory/128G SSD/COM port*2/USB2.0 *4+USB3.0 *2/Gigabit LAN port*4/VGA *1/HDMI*1/Line-out*1/MIC*1/19V DC power supply/19V power adapter*1/Al-alloy front panel/capacitive touch screen
0010-174661	W15-91	15.6" panel PC/Intel®H110 chipset/I5-7500T 2.7Ghz quad-core processor/8GB memory/128G SSD/COM port*6/USB2.0 *4+USB3.0 *4 /Gigabit LAN port*2/VGA port*1/HDMI*1/DVI*1/GPIO*1/Line-out*1/MIC*1/Line-in*1/19V DC power supply/19V power adapter*1/Al-alloy front panel/capacitive touch screen
0010-174671	W15-92	15.6" panel PC/Intel®C236 chipset/I7-8700 3.2Ghz six-core processor/8GB memory/128G SSD/COM port*5/USB3.0*8/Gigabit LAN port*4/VGA*1/HDMI*1/DVI*1/GPIO*1/Line-out*1/MIC*1/Line-in*1/19V DC power supply/19V power adapter*1/Al-alloy front panel/capacitive touch screen

Note: The final interpretation rights for product specifications, ordering information, etc. belong to EVOC Intelligent Technology Co., Ltd.







W18A

19" Wide-screen Industrial panel PC

W18A series is a 19" wide-screen industrial panel PC, featuring multi-touch, and effective integration of high reliability and industrial aesthetics. The product supports multiple platforms, such as Intel H110/H310/Q370/C236, Intel Skylake-U SOC, Intel Bay Trail, etc., and supports Windows 7 (64bit), Windows10, LINUX (2.6 kernel) and other operating systems. This series targets high-end MES, comprehensive monitoring, automation and other fields, and is mainly used in harsh industrial on-site control applications, such as production line MES, comprehensive monitoring (rail transit, buildings, power, etc.), medical informatization, single crystal furnace machines, and wind power.



Product Features

						
Fashionable appearance, ruggedness and durability	Multiple ports and expansibility	Industrial-grade touch screen	Touch buttons	Fully-sealed and fanless design	Protection grade IP65	Multiple mounting methods

Product Dimensions Drawing

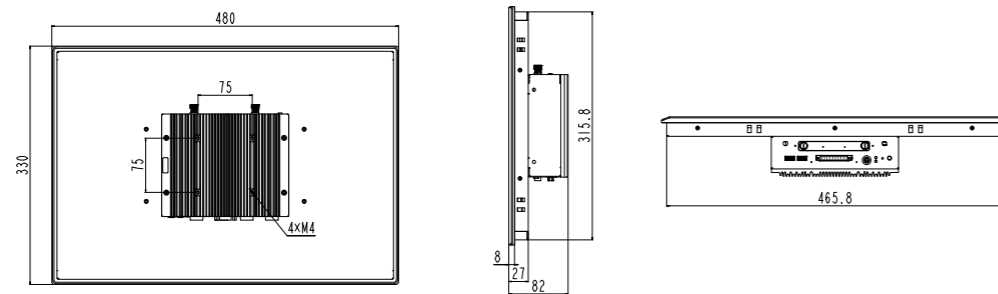

Please refer to the user manual to check detailed specifications and dimension. (Unit: MM)

Product Specifications

Item		Description		
Display Performance	Screen Size	19" TFT LCD 16:10	Brightness	250cd/m ²
	Maximum Resolution	1440x900	Contrast Ratio	1000:1
Touch Screen		Capacitive touch screen, multi-touch;		
System Configuration	Processor	Intel® Celeron J1900 2.0Ghz quad-core, onboard processor that is non-replaceable; SkyLake-U: onboard Intel® I3-6100U/I5-6300U/I7-6600U processors; H110/C236: supports 6/7/8th Gen Intel® Core™ I3/I5/I7 series, and supports 9th Gen Intel® Core™ I3/I5 series, LGA1151, CPU TDP ≤ 65W; H310/Q370: supports 8/9th Gen Intel® Core™ I3/I5/I7 series, Celeron, Pentium series processors, LGA1151, CPU TDP ≤ 65W;		
	Chipset	Intel® BayTrail; SkyLake-U; H110/C236; H310/Q370;		
	Memory	BayTrail: supports 1 x 204Pin DDR3L SO-DIMM slot, supporting up to 8GB; SkyLake-U: supports 1 x 260Pin DDR4 SO-DIMM memory slot, onboard 4GB, the slot supporting up to 16GB, and the PC memory supporting up to 20GB; H110/C236/H310/Q370: supports 2 x 260Pin DDR4 SO-DIMM memory slot, single slot supporting up to 32GB, and the PC memory supporting up to 64GB;		
I/O Ports	LAN Port	Optional 2/4/6 x RJ45 10/100/1000Mbps LAN port;		
	Display	BayTrail/ SkyLake-U: supports VGA and HDMI display ports; H110/C236/H310/Q370: supports VGA, HDMI and DVI display ports;		
	USB	BayTrail: 1 x USB3.0+5 x USB2.0 port; SkyLake-U: 2 x USB3.0+2 x USB2.0 port; H110: 4 x USB3.0+4 x USB2.0 port; C236: 8 x USB3.0; H310/Q370: 4 x USB3.0+4 x USB2.0 port;		
	COM	2~6 x COM port;(depending on specific configurations)		
	Audio	BayTrail/SkyLake-U: 1 group of Audio ports (supporting MIC-IN and LINE-OUT); H110/C236/H310/Q370: 1 group of Audio ports (supporting MIC-IN, LINE-OUT and LINE-IN);		
	Expansion Slot	Expansion slot depends on specific configurations;		
Storage	Hard Disk	BayTrail/SkyLake-U: 1 x SATA interface; H110/C236/H310/Q370: 2 x SATA interface;		
	M-SATA/M.2	BayTrail/SkyLake-U: 1 x M-SATA slot; H110/C236: 1 x M-SATA slot, 1 x M.2 keyM slot; H310: 1 x M.2 keyB slot; Q370: 1 x M.2 keyM slot;		
Working Environment	CPU power consumption	With HDD	With SSD/electronic hard disk	
	CPU TDP < 35W	0°C~+45°C	0°C~+50°C	
	35W ≤ CPU TDP ≤ 65W	0°C~+40°C	0°C~+50°C	
Note: the air flow rate in the working environment of the PC depends on specific configurations;				
Storage Environment	-20°C~+60°C; humidity: 5%~95% (non-condensing)			
Dimensions	480mm (W) x 330mm (H) (depth depending on specific configurations)			
Mounting Dimensions	469mm (W) x 319mm (H)			
Material of Front Panel	High-strength Al-alloy front panel, and the front panel meets IP65 grade;			
Mounting Method	Embedded type, VESA standard arm;			
Power Supply	BayTrail: 1 x 2Pin phoenix terminal power connector, 1 x 2Pin phoenix terminal remote switch port, input voltage depending on specific configurations; SkyLake-U/H110/C236/H310/Q370: 1 x 4Pin phoenix terminal power connector, input voltage depending on specific configurations;			

Ordering Information

Part No.	Description	Specifications
0010-154821	W18A-01	19" panel PC/Intel® BayTrail chipset/Celeron J1900 2.0Ghz quad-core processor/4GB memory/128G SSD/COM port*4/USB port*4/Gigabit LAN port*2/VGA*1/HDMI*1/PS/2*1/Line-out*1/MIC*1/9~30V DC power supply/power adapter/Al-alloy front panel/capacitive touch screen
0010-154831	W18A-31	19" panel PC/Intel® Skylake SOC chipset/I3-6100U 2.3Ghz dual-core processor/4GB memory/128G SSD/COM port*2/USB port*6/Gigabit LAN port*4/VGA*1/HDMI*1/PS/2*1/Line-out*1/ Mic-in*1/9~30V DC power supply/power adapter/Al-alloy front panel/capacitive touch screen
0010-154841	W18A-51	19" panel PC/Intel® H110 chipset/I3-6100TE 2.7Ghz dual-core processor/4GB memory/128G SSD/COM port*6/USB port*8/Gigabit LAN port*2/VGA*1/HDMI*1/DVI*1/PS/2*1/Line-out*1/MIC*1/Line-in*1/9~36V DC power supply/power adapter/Al-alloy front panel
0010-174681	W18A-61	19" panel PC/Intel® BayTrail chipset/Celeron J1900 2.0Ghz quad-core processor/4GB memory/128G SSD/COM port*2/USB2.0*5+USB3.0*1/Gigabit LAN port*4/VGA*1/HDMI*1/Line-out*1/MIC*1/12V DC power supply/12V power adapter*1/Al-alloy front panel/capacitive touch screen
0010-174691	W18A-62	19" panel PC/Intel Skylake SOC chipset/I3-6100U 2.3Ghz dual-core processor/4GB memory/128G SSD/COM port*4/USB2.0*2+USB3.0*2/Gigabit LAN port*2/VGA port*1/HDMI*1/Line-out*1/MIC*1/19V DC power supply/19V power adapter*1/Al-alloy front panel/capacitive touch screen
0010-174701	W18A-91	19" panel PC/Intel® H110 chipset/I5-7500T 2.7Ghz quad-core processor/8GB memory/128G SSD/COM port*6/USB2.0*4+USB3.0*4/Gigabit LAN port*2/VGA port*1/HDMI*1/DVI*1/8-bit GPIO*1/Line-out*1/MIC*1/Line-in*1/19V DC power supply/19V power adapter*1/Al-alloy front panel/capacitive touch screen
0010-174711	W18A-92	19" panel PC/Intel® C236 chipset/I7-8700 3.2Ghz six-core processor/8GB memory/128G SSD/COM port*5/USB3.0*8/Gigabit LAN port*4/VGA*1/HDMI*1/DVI*1/GPIO*1/Line-out*1/MIC*1/Line-in*1/19V DC power supply/19V power adapter*1/Al-alloy front panel/capacitive touch screen

Note: The final interpretation rights for product specifications, ordering information, etc. belong to EVOC Intelligent Technology Co., Ltd.

W21

21.5" Wide-screen Industrial panel PC

W21 series is a 21.5" wide-screen industrial panel PC, featuring multi-touch, and effective integration of high reliability and industrial aesthetics. The product supports multiple platforms, such as Intel H110/H310/Q370/C236, Intel Skylake-U SOC, Intel Bay Trail, etc., and supports Windows 7 (64bit), Windows10, LINUX (2.6 kernel) and other operating systems. This series is mainly used in harsh industrial on-site control applications, such as production line MES, comprehensive monitoring (rail transit, buildings, power, etc.), medical informatization, single crystal furnace machines, and wind power.



Product Features



Fashionable appearance, ruggedness and durability



Multiple ports and expansibility



Industrial-grade touch screen



Touch buttons



Fully-sealed and fanless design



Protection grade IP65



Multiple mounting methods

Product Dimensions Drawing

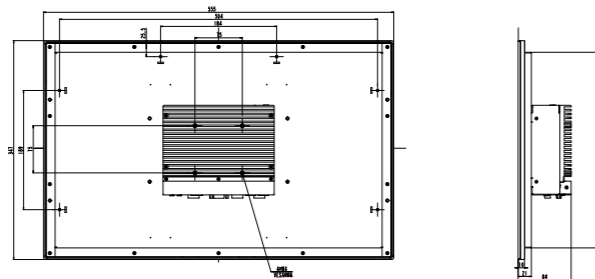

Please refer to the user manual to check detailed specifications and dimension. (Unit: MM)

Product Specifications

Item		Description		
Display Performance	Screen Size	21.5" TFT LCD 16:9	Brightness	250cd/m ²
	Maximum Resolution	1920x1080	Contrast Ratio	1000:1
Touch Screen		Capacitive touch screen, multi-touch;		
System Configuration	Processor	Intel® Celeron J1900 2.0Ghz quad-core, onboard processor that is non-replaceable; SkyLake-U: onboard Intel® I3-6100U/I5-6300U/I7-6600U processors; H110/C236: supports 6/7/8th Gen Intel® Core™ I3/I5/I7 series, and supports 9th Gen Intel® Core™ I3/I5 series, LGA1151, CPU TDP ≤ 65W; H310/Q370: supports 8/9th Gen Intel® Core™ I3/I5/I7 series, Cleron, Pentium series processors, LGA1151, CPU TDP ≤ 65W;		
	Chipset	Intel® BayTrail; SkyLake-U; H110/C236; H310/Q370;		
	Memory	BayTrail: supports 1 x 204Pin DDR3L SO-DIMM slot, supporting up to 8GB; SkyLake-U: supports 1 x 260Pin DDR4 SO-DIMM memory slot, onboard 4GB, the slot supporting up to 16GB, and the PC memory supporting up to 20GB; H110/C236/H310/Q370: supports 2 x 260Pin DDR4 SO-DIMM memory slot, single slot supporting up to 32GB, and the PC memory supporting up to 64GB;		
I/O Ports	LAN Port	Optional 2/4/6 x RJ45 10/100/1000Mbps LAN port;		
	Display	BayTrail/ SkyLake-U: supports VGA and HDMI display ports; H110/C236/H310/Q370: supports VGA, HDMI and DVI display ports;		
	USB	BayTrail: 1 x USB3.0+5 x USB2.0 port; SkyLake-U: 2 x USB3.0+2 x USB2.0 port; H110: 4 x USB3.0+4 x USB2.0 port; C236: 8 x USB3.0; H310/Q370: 4 x USB3.0+4 x USB2.0 port;		
	COM	2~6 x COM port;(depending on specific configurations)		
	Audio	BayTrail/SkyLake-U: 1 group of Audio ports (supporting MIC-IN and LINE-OUT); H110/C236/H310/Q370: 1 group of Audio ports (supporting MIC-IN, LINE-OUT and LINE-IN);		
	Expansion Slot	Expansion slot depends on specific configurations;		
Storage	Hard Disk	BayTrail/SkyLake-U: 1 x SATA interface; H110/C236/H310/Q370: 2 x SATA interface;		
	M-SATA/M.2	BayTrail/SkyLake-U: 1 x M-SATA slot; H110/C236: 1 x M-SATA slot, 1 x M.2 keyM slot; Q370: 1 x M.2 keyM slot;		
Working Environment	CPU power consumption	With HDD	With SSD/electronic hard disk	
	CPU TDP < 35W	0°C~+45°C	0°C~+50°C	
	35W ≤ CPU TDP ≤ 65W	0°C~+40°C	0°C~+50°C	
Note: the air flow rate in the working environment of the PC depends on specific configurations;				
Storage Environment	-30°C~+65°C; humidity: 5%~95% (non-condensing)			
Dimensions	555mm (W) x 347mm (H)(depth depending on specific configurations)			
Mounting Dimensions	521mm (W) x 313mm (H)			
Material of Front Panel	High-strength Al-alloy front panel, and the front panel meets IP65 grade;			
Mounting Method	Embedded type, VESA standard arm;			
Power Supply	BayTrail: 1 x 2Pin phoenix terminal power connector, 1 x 2Pin phoenix terminal remote switch port, input voltage depending on specific configurations; SkyLake-U/H110/C236/H310/Q370: 1 x 4Pin phoenix terminal power connector, input voltage depending on specific configurations;			

Ordering Information

Part No.	Description	Specifications
0010-115521	W21-01	21.5" panel PC/Intel®BayTrail chipset/Celeron J1900 2.0Ghz quad-core processor/4GB memory/500G hard disk/COM port*4/USB port*4/Gigabit LAN port*2/VGA*1/HDMI*1/PS/2*1/Line-out*1/ MIC*1/9~30V DC power supply/power adapter/Al-alloy front panel/capacitive touch screen
0010-115531	W21-31	21.5" panel PC/Intel®Skylake SOC chipset/I3-6100U 2.3Ghz dual-core processor/4GB memory/500G hard disk/COM port*4/USB port*4/Gigabit LAN port*2/VGA*1/HDMI*1/PS/2*1/Line-out*1/ Mic-in*1/9~30V DC power supply/power adapter/Al-alloy front panel/capacitive touch screen
0010-115541	W21-32	21.5" panel PC/Intel®Skylake SOC chipset/I5-6300U 2.4Ghz dual-core processor/4GB memory/500G hard disk/COM port*4/USB port*4/Gigabit LAN port*2/VGA*1/HDMI*1/PS/2*1/Line-out*1/Mic-in*1/9~30V DC power supply/power adapter/Al-alloy front panel/capacitive touch screen
0010-114031	W21-51	21.5" panel PC/Intel®H110 chipset/I3-6100T 2.7Ghz dual-core processor/4GB memory/500G hard disk/COM port*6/USB port*8/Gigabit LAN port*2/VGA*1/HDMI*1/DVI*1/PS/2*1/ Line-out*1/ MIC*1/Line-in*1/9~36VDC power supply/power adapter/Al-alloy front panel
0010-174721	W21-61	21.5" panel PC/Intel®BayTrail chipset/Celeron J1900 2.0Ghz quad-core processor/no memory/no hard disk/COM port*2/USB2.0 *5+USB3.0*1/Gigabit LAN port*4/VGA *1/HDMI*1/ Line-out*1/MIC*1/12V DC power supply/12V power adapter*1/Al-alloy front panel/capacitive touch screen
0010-174731	W21-62	21.5" panel PC/Intel Skylake SOC chipset/I3-6100U 2.3Ghz dual-core processor/4GB memory/128G SSD/COM port*4/USB2.0*2+USB3.0*2/Gigabit LAN port*2/VGA port*1/HDMI*1/Line-out*1/MIC*1/19V DC power supply/19V power adapter*1/Al-alloy front panel/capacitive touch screen
0010-174741	W21-63	21.5" panel PC/Intel®Skylake SOC chipset/I5-6300U 2.4Ghz dual-core processor/8GB memory/128G SSD/COM port*4/USB2.0 *2+USB3.0 *2/Gigabit LAN port*2/VGA*1/HDMI*1/Line-out*1/MIC*1/19V DC power supply/19V power adapter*1/Al-alloy front panel/capacitive touch screen
0010-174751	W21-64	21.5" panel PC/Intel®Skylake SOC chipset/ I7-6600U 2.6Ghz dual-core processor/8GB memory/128G SSD/COM port*2/USB2.0 *4+USB3.0 *2/Gigabit LAN port*4/VGA*1/HDMI*1/Line-out*1/MIC*1/19V DC power supply/19V power adapter*1/Al-alloy front panel/capacitive touch screen
0010-174761	W21-91	21.5" panel PC/Intel®H110 chipset/I5-7500T 2.7Ghz quad-core processor/8GB memory/128G SSD/COM port*6/USB2.0*4+USB3.0*4/Gigabit LAN port*2/VGA*1/HDMI*1/DVI*1/8-bit GPIO*1/Line-out*1/MIC*1/Line-in*1/19V DC power supply/19V power adapter*1/Al-alloy front panel/capacitive touch screen
0010-174771	W21-92	21.5" panel PC/Intel®C236 chipset/I7-8700 3.2Ghz six-core processor/8GB memory/128G SSD/COM port*5/USB3.0*8/Gigabit LAN port*4/VGA*1/HDMI*1/DVI*1/GPIO*1/Line-out*1/MIC*1/Line-in*1/19V DC power supply/19V power adapter*1/Al-alloy front panel/capacitive touch screen

Note: The final interpretation rights for product specifications, ordering information, etc. belong to EVOC Intelligent Technology Co., Ltd.

P12

12 " Square-screen Industrial Panel PC

P12 series is a 12" square-screen industrial Panel PC, supporting multiple platforms, such as Intel H110/H310/Q370/C236, Intel Skylake-USOC and Intel Bay Trail, and supports Windows 7 (64bit), Windows10, LINUX (2.6 kernel) and other operating systems. This series targets high-end MES, comprehensive monitoring, equipment control and other fields, and is mainly used in shield tunnel boring machines, production line MES, comprehensive monitoring (rail transit, buildings, power, etc.), CNC, single crystal furnace machines, auto parts control, etc.



Product Features



Fashionable appearance, ruggedness and durability



Multiple ports and expansibility



Multiple mounting methods



Protection grade IP65



Full-sealed and fanless design

Product Dimensions Drawing

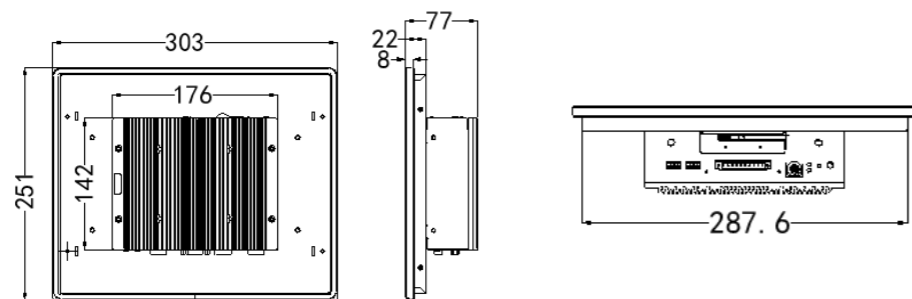

Please refer to the user manual to check detailed specifications and dimension. (Unit: MM)

Product Specifications

Item		Description		
Display Performance	Screen Size	12" TFT LCD 4:3	Brightness	350cd/m ²
	Maximum Resolution	1024x768	Contrast Ratio	800:1
Touch Screen		5-wire resistive touch screen, single-touch;		
System Configuration	Processor	Intel® Celeron J1900 2.0Ghz quad-core, onboard processor that is non-replaceable; SkyLake-U: onboard Intel® I3-6100U/I5-6300U/I7-6600U processors; H110/C236: supports 6/7/8th Gen Intel® Core™ I3/I5/I7 series, and supports 9th Gen Intel® Core™ I3/I5 series, LGA1151, CPU TDP ≤ 65W; H310/Q370: supports 8/9th Gen Intel® Core™ I3/I5/I7 series, Cleron, Pentium series processors, LGA1151, CPU TDP ≤ 65W;		
	Chipset	Intel® BayTrail; SkyLake-U; H110/C236; H310/Q370;		
	Memory	BayTrail: supports 1 x 204Pin DDR3L SO-DIMM slot, supporting up to 8GB; SkyLake-U: supports 1 x 260Pin DDR4 SO-DIMM memory slot, onboard 4GB, the slot supporting up to 16GB, and the PC memory supporting up to 20GB; H110/C236/H310/Q370: supports 2 x 260Pin DDR4 SO-DIMM memory slot, single slot supporting up to 32GB, and the PC memory supporting up to 64GB;		
I/O Ports	LAN Port	Optional 2/4/6 x RJ45 10/100/1000Mbps LAN port;		
	Display	BayTrail/ SkyLake-U: supports VGA and HDMI display ports; H110/C236/H310/Q370: supports VGA, HDMI and DVI display ports;		
	USB	BayTrail: 1 x USB3.0+5 x USB2.0 port; SkyLake-U: 2 x USB3.0+2 x USB2.0 port; H110: 4 x USB3.0+4 x USB2.0 port; C236: 8 x USB3.0; H310/Q370: 4 x USB3.0+4 x USB2.0 port;		
	COM	2~6 x COM port; (depending on specific configurations)		
	Audio	BayTrail/SkyLake-U: 1 group of Audio ports (supporting MIC-IN and LINE-OUT); H110/C236/H310/Q370: 1 group of Audio ports (supporting MIC-IN, LINE-OUT and LINE-IN);		
	Expansion Slot	Expansion slot depends on specific configurations;		
Storage	Hard Disk	BayTrail/SkyLake-U: 1 x SATA interface; H110/C236/H310/Q370: 2 x SATA interface;		
	M-SATA/M.2	BayTrail/SkyLake-U: 1 x M-SATA slot; H110/C236: 1 x M-SATA slot, 1 x M.2 keyM slot; H310: 1 x M.2 keyB slot; Q370: 1 x M.2 keyM slot;		
Working Environment	CPU power consumption	With HDD	With SSD/electronic hard disk	
	CPU TDP < 35W	0°C~+45°C	0°C~+50°C	
	35W ≤ CPU TDP ≤ 65W	0°C~+40°C	0°C~+50°C	
Note: the air flow rate in the working environment of the PC depends on specific configurations;				
Storage Environment		-20°C~+60°C; humidity: 5%~95% (non-condensing)		
Dimensions		303mm (W) x 251mm (H) (depth depending on specific configurations)		
Mounting Dimensions		290.6mm (W) x 238.6mm (H)		
Material of Front Panel		High-strength Al-alloy front panel, and the front panel meets IP65 grade;		
Mounting Method		Embedded type, VESA standard arm;		
Power Supply		BayTrail: 1 x 2Pin phoenix terminal power connector, 1 x 2Pin phoenix terminal remote switch port, input voltage depending on specific configurations; SkyLake-U/H110/C236/H310/Q370: 1 x 4Pin phoenix terminal power connector, input voltage depending on specific configurations;		

Ordering Information

Part No.	Description	Specifications
0010-119501	P12-01	12 " Panel PC/Intel® BayTrail chipset/Celeron J1900 2.0Ghz quad-core processor/4GB memory/500G hard disk/COM port*4/USB port*4/Gigabit LAN port*2/VGA*1/HDMI*1/PS/2*1/Line-out*1/MIC*1/8-channel GPIO*1/9~30VDC power supply/power adapter/Al-alloy front panel
0010-119511	P12-31	12 " Panel PC/Intel® H110 chipset/I3-6100TE 2.7Ghz dual-core processor/4GB memory/500G hard disk/COM port*6/USB port*8/Gigabit LAN port*2/VGA*1/HDMI*1/DVI*1/PS/2*1/Line-out*1/ MIC*1/Line-in*1/8-bit GPIO*1/9~36V DC power supply/power adapter/Al-alloy front panel
0010-174441	P12-61	12 " Panel PC/Intel® BayTrail chipset/Celeron J1900 2.0Ghz quad-core processor/4GB memory/128G SSD/COM port*2/USB2.0 *5+ USB3.0 *1/Gagabit LAN port*4/VGA*1/HDMI*1/Line-out*1/MIC*1/12V DC power supply/12V power adapter*1/Al-alloy front panel/resistive touch screen
0010-174451	P12-62	12 " Panel PC/Intel Skylake SOC chipset/I3-6100U 2.3Ghz dual-core processor/4GB memory/128G SSD/COM port*4/USB2.0*2+USB3.0*2 /Gagabit LAN port*2/VGA port*1/HDMI*1/Line-out*1/MIC*1/19V DC power supply/19V power adapter*1/Al-alloy front panel/resistive touch screen
0010-174461	P12-91	12 " Panel PC/Intel® H110 chipset/I5-7500T 2.7Ghz quad-core processor/8GB memory/128G SSD/COM port*6/USB2.0*4+USB3.0*4/Gagabit LAN port*2/VGA port*1/HDMI*1/DVI*1/8-bit GPIO*1/Line-out*1/MIC*1/Line-in*1/19V DC power supply/19V power adapter*1/Al-alloy front panel/resistive touch screen
0010-174471	P12-92	12 " Panel PC/Intel® C236 chipset/I7-8700 3.2Ghz six-core processor/8GB memory/128G SSD/COM port*5/USB3.0*8/Gagabit LAN port*4/VGA*1/HDMI*1/DVI*1/GPIO*1/Line-out*1/MIC*1/Line-in*1/19V DC power supply/19V power adapter*1/Al-alloy front panel/resistive touch screen

Note: The final interpretation rights for product specifications, ordering information, etc. belong to EVOC Intelligent Technology Co., Ltd.

P15

15" Square-screen Industrial Panel PC

P15 series is a 15" square-screen industrial Panel PC, supporting multiple platforms, such as Intel H110/H310/Q370/C236, Intel Skylake-U SOC and Intel Bay Trail, and supports Windows 7 (64bit), Windows10, LINUX (2.6 kernel) and other operating systems. This series targets high-end MES, comprehensive monitoring, equipment control and other fields, and is mainly used in shield tunnel boring machines, production line MES, comprehensive monitoring (rail transit, buildings, power, etc.), CNC, single crystal furnace machines, auto parts control, etc.



Product Features



Fashionable appearance, ruggedness and durability



Multiple ports and expansibility



Multiple mounting methods



Protection grade IP65



Full-sealed and fanless design

Product Dimensions Drawing

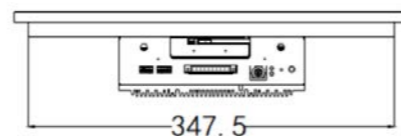
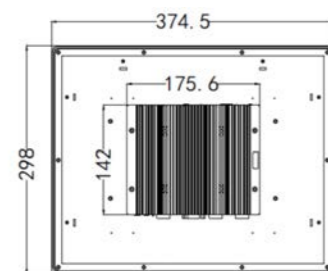

Please refer to the user manual to check detailed specifications and dimension. (Unit: MM)

Product Specifications

Item		Description		
Display Performance	Screen Size	15" TFT LCD 4:3	Brightness	300cd/m ²
	Maximum Resolution	1024x768	Contrast Ratio	600:1
Touch Screen		5-wire resistive touch screen, single-touch;		
System Configuration	Processor	Intel® Celeron J1900 2.0Ghz quad-core, onboard processor that is non-replaceable; SkyLake-U: onboard Intel® I3-6100U/I5-6300U/I7-6600U processors; H110/C236: supports 6/7/8th Gen Intel® Core™ I3/I5/I7 series, and supports 9th Gen Intel® Core™ I3/I5 series, LGA1151, CPU TDP ≤ 65W; H310/Q370: supports 8/9th Gen Intel® Core™ I3/I5/I7 series, Cleron, Pentium series processors, LGA1151, CPU TDP ≤ 65W;		
	Chipset	Intel® BayTrail; SkyLake-U; H110/C236; H310/Q370;		
	Memory	BayTrail: supports 1 x 204Pin DDR3L SO-DIMM slot, supporting up to 8GB; SkyLake-U: supports 1 x 260Pin DDR4 SO-DIMM memory slot, onboard 4GB, the slot supporting up to 16GB, and the PC memory supporting up to 20GB; H110/C236/H310/Q370: supports 2 x 260Pin DDR4 SO-DIMM memory slot, single slot supporting up to 32GB, and the PC memory supporting up to 64GB;		
I/O Ports	LAN Port	Optional 2/4/6 x RJ45 10/100/1000Mbps LAN port;		
	Display	BayTrail/ SkyLake-U: supports VGA and HDMI display ports; H110/C236/H310/Q370: supports VGA, HDMI and DVI display ports;		
	USB	BayTrail: 1 x USB3.0+5 x USB2.0 port; SkyLake-U: 2 x USB3.0+2 x USB2.0 port; H110: 4 x USB3.0+4 x USB2.0 port; C236: 8 x USB3.0; H310/Q370: 4 x USB3.0+4 x USB2.0 port;		
	COM	2~6 x COM port; (depending on specific configurations)		
	Audio	BayTrail/SkyLake-U: 1 group of Audio ports (supporting MIC-IN and LINE-OUT); H110/C236/H310/Q370: 1 group of Audio ports (supporting MIC-IN, LINE-OUT and LINE-IN);		
	Expansion Slot	Expansion slot depends on specific configurations;		
Storage	Hard Disk	BayTrail/SkyLake-U: 1 x SATA interface; H110/C236/H310/Q370: 2 x SATA interface;		
	M-SATA/M.2	BayTrail/SkyLake-U: 1 x M-SATA slot; H110/C236: 1 x M-SATA slot, 1 x M.2 keyM slot; H310: 1 x M.2 keyB slot; Q370: 1 x M.2 keyM slot;		
Working Environment	CPU power consumption	With HDD	With SSD/electronic hard disk	
	CPU TDP < 35W	0°C~+45°C	0°C~+50°C	
	35W ≤ CPU TDP ≤ 65W	0°C~+40°C	0°C~+50°C	
Note: the air flow rate in the working environment of the PC depends on specific configurations;				
Storage Environment	-20°C~+60°C; humidity: 5%~95% (non-condensing)			
Dimensions	374.5mm (W) x 298mm (H) (depth depending on specific configurations)			
Mounting Dimensions	350.5mm (W) x 274mm (H)			
Material of Front Panel	High-strength Al-alloy front panel, and the front panel meets IP65 grade;			
Mounting Method	Embedded type, VESA standard arm;			
Power Supply	BayTrail: 1 x 2Pin phoenix terminal power connector, 1 x 2Pin phoenix terminal remote switch port, input voltage depending on specific configurations; SkyLake-U/H110/C236/H310/Q370: 1 x 4Pin phoenix terminal power connector, input voltage depending on specific configurations;			

Ordering Information

Part No.	Description	Specifications
0010-117221	P15-01	15" Panel PC/Intel® BayTrail chipset/Celeron J1900 2.0Ghz quad-core processor/4GB memory/500G hard disk/COM port*4/USB port*4/Gigabit LAN port*2/VGA*1/HDMI*1/PS/2*1/Lin-out*1/MIC*1/8-channel GPIO*1/9~30VDC power supply/power adapter/Al-alloy panel/resistive touch screen
0010-117231	P15-31	15" Panel PC/Intel® H110 chipset/I3-6100T 2.7Ghz dual-core processor/4GB memory/500G hard disk/COM port*6/USB port*8/Gigabit LAN port*2/VGA*1/HDMI*1/DVI*1/PS/2*1/Lin-out*1/MIC*1/Line-in*1/8-channel GPIO*1/9~36V DC power supply/power adapter/Al-alloy panel/resistive touch screen
0010-174481	P15-61	15" Panel PC/Intel® BayTrail chipset/Celeron J1900 2.0Ghz quad-core processor/4GB memory/128G SSD/COM port*2/USB2.0*5+USB3.0*1/Gigabit LAN port*4/VGA*1/HDMI*1/Line-out*1/MIC*1/12V DC power supply/12V power adapter*1/Al-alloy front panel/resistive touch screen
0010-174491	P15-62	15" Panel PC/Intel Skylake SOC chipset/I3-6100U 2.3Ghz dual-core processor/4GB memory/128G SSD/COM port*4/USB2.0*2+USB3.0*2/Gigabit LAN port*2/VGA port*1/HDMI*1/Line-out*1/MIC*1/19V DC power supply/19V power adapter*1/Al-alloy front panel/resistive touch screen
0010-174501	P15-91	15" Panel PC/Intel® H110 chipset/I5-7500T 2.7Ghz quad-core processor/8GB memory/128G SSD/COM port*6/USB2.0*4+USB3.0*4/Gigabit LAN port*2/VGA port*1/HDMI*1/DVI*1/8位GPIO*1/Line-out*1/MIC*1/Line-in*1/19V DC power supply/19V power adapter*1/Al-alloy front panel/resistive touch screen
0010-174511	P15-92	15" Panel PC/Intel® C236 chipset/I7-8700 3.2Ghz six-core processor/8GB memory/128G SSD/COM port*5/USB3.0*8/Gigabit LAN port*4/VGA*1/HDMI*1/DVI*1/GPIO*1/Line-out*1/MIC*1/Line-in*1/19V DC power supply/19V power adapter*1/Al-alloy front panel/resistive touch screen

Note: The final interpretation rights for product specifications, ordering information, etc. belong to EVOC Intelligent Technology Co., Ltd.

P17

17" Square-screen Industrial Panel PC

P17 series is a 17" square-screen industrial Panel PC, supporting multiple platforms, such as Intel H110/H310/Q370/C236, Intel Skylake-U SOC and Intel Bay Trail, and supports Windows 7 (64bit), Windows10, LINUX (2.6 kernel) and other operating systems. This series targets high-end MES, comprehensive monitoring, equipment control and other fields, and is mainly used in shield tunnel boring machines, production line MES, comprehensive monitoring (rail transit, buildings, power, etc.), CNC, single crystal furnace machines, auto parts control, etc.



Product Features



Fashionable appearance, ruggedness and durability



Multiple ports and expansibility



Multiple mounting methods



Protection grade IP65



Full-sealed and fanless design

Product Dimensions Drawing

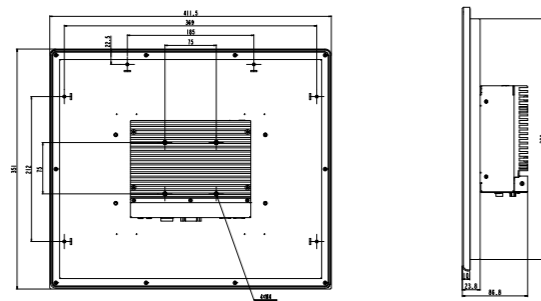

Please refer to the user manual to check detailed specifications and dimension. (Unit: MM)

Product Specifications

Item		Description		
Display Performance	Screen Size	17" TFT LCD 5:4	Brightness	250cd/m ²
	Maximum Resolution	1280x1024	Contrast Ratio	1000:1
Touch Screen		5-wire resistive touch screen, single-touch;		
System Configuration	Processor	Intel® Celeron J1900 2.0Ghz quad-core, onboard processor that is non-replaceable; SkyLake-U: onboard Intel® I3-6100U/I5-6300U/I7-6600U processors; H110/C236: supports 6/7/8th Gen Intel® Core™ I3/I5/I7 series, and supports 9th Gen Intel® Core™ I3/I5 series, LGA1151, CPU TDP ≤ 65W; H310/Q370: supports 8/9th Gen Intel® Core™ I3/I5/I7 series, Cleron, Pentium series processors, LGA1151, CPU TDP ≤ 65W;		
	Chipset	Intel® BayTrail; SkyLake-U; H110/C236; H310/Q370;		
	Memory	BayTrail: supports 1 x 204Pin DDR3L SO-DIMM slot, supporting up to 8GB; SkyLake-U: supports 1 x 260Pin DDR4 SO-DIMM memory slot, onboard 4GB, the slot supporting up to 16GB, and the PC memory supporting up to 20GB; H110/C236/H310/Q370: supports 2 x 260Pin DDR4 SO-DIMM memory slot, single slot supporting up to 32GB, and the PC memory supporting up to 64GB;		
I/O Ports	LAN Port	Optional 2/4/6 x RJ45 10/100/1000Mbps LAN port;		
	Display	BayTrail/ SkyLake-U: supports VGA and HDMI display ports; H110/C236/H310/Q370: supports VGA, HDMI and DVI display ports;		
	USB	BayTrail: 1 x USB3.0+5 x USB2.0 port; SkyLake-U: 2 x USB3.0+2 x USB2.0 port; H110: 4 x USB3.0+4 x USB2.0 port; C236: 8 x USB3.0; H310/Q370: 4 x USB3.0+4 x USB2.0 port;		
	COM	2~6 x COM port; (depending on specific configurations)		
	Audio	BayTrail/SkyLake-U: 1 group of Audio ports (supporting MIC-IN and LINE-OUT); H110/C236/H310/Q370: 1 group of Audio ports (supporting MIC-IN, LINE-OUT and LINE-IN);		
	Expansion Slot	Expansion slot depends on specific configurations;		
Storage	Hard Disk	BayTrail/SkyLake-U: 1 x SATA interface; H110/C236/H310/Q370: 2 x SATA interface;		
	M-SATA/M.2	BayTrail/SkyLake-U: 1 x M-SATA slot; H110/C236: 1 x M-SATA slot, 1 x M.2 keyM slot; H310: 1 x M.2 keyB slot; Q370: 1 x M.2 keyM slot;		
Working Environment	CPU power consumption	With HDD	With SSD/electronic hard disk	
	CPU TDP < 35W	0°C~+45°C	0°C~+50°C	
	35W ≤ CPU TDP ≤ 65W	0°C~+40°C	0°C~+50°C	
Note: the air flow rate in the working environment of the PC depends on specific configurations;				
Storage Environment	-20°C~+60°C; humidity: 5%~95% (non-condensing)			
Dimensions	411.5mm (W) x 351mm (H) (depth depending on specific configurations)			
Mounting Dimensions	386mm (W) x 323mm (H)			
Material of Front Panel	High-strength Al-alloy front panel, and the front panel meets IP65 grade;			
Mounting Method	Embedded type, VESA standard arm;			
Power Supply	BayTrail: 1 x 2Pin phoenix terminal power connector, 1 x 2Pin phoenix terminal remote switch port, input voltage depending on specific configurations; SkyLake-U/H110/C236/H310/Q370: 1 x 4Pin phoenix terminal power connector, input voltage depending on specific configurations;			

Ordering Information

Part No.	Description	Specifications
0010-117241	P17-01	17" Panel PC/Intel® BayTrail chipset/Celeron J1900 2.0Ghz quad-core processor/4GB memory/500G hard disk/COM port*6/USB port*8/Gigabit LAN port*2/VGA*1/HDMI*1/PS/2*1/Line-out*1/MIC*1/Line-in*1/8-channel GPIO*1/9~30V DC power supply/power adapter/Al-alloy panel/resistive touch screen
0010-117251	P17-31	17" Panel PC/Intel® Skylake SOC chipset/I3-6100U 2.3Ghz dual-core processor/4GB memory/500G hard disk/COM port*4/USB port*4/Gigabit LAN port*2/VGA*1/HDMI*1/PS/2*1/Line-out*1/MIC*1/8-channel GPIO*1/9~30V DC power supply/power adapter/Al-alloy panel/resistive touch screen
0010-174521	P17-61	17" Panel PC/Intel® BayTrail chipset/Celeron J1900 2.0Ghz quad-core processor/4GB memory/128G SSD/COM port*2/USB2.0*5+USB3.0*1/Gigabit LAN port*4/VGA*1/HDMI*1/Line-out*1/MIC*1/12V DC power supply/12V power adapter*1/Al-alloy panel/resistive touch screen
0010-174531	P17-62	17" Panel PC/Intel Skylake SOC chipset/I3-6100U 2.3Ghz dual-core processor/4GB memory/128G SSD/COM port*4/USB2.0*2+USB3.0*2/Gigabit LAN port*2/VGA port*1/HDMI*1/Line-out*1/MIC*1/19V DC power supply/19V power adapter*1/Al-alloy panel/resistive touch screen
0010-174541	P17-91	17" Panel PC/Intel® BayTrail chipset/Celeron J1900 processor/4GB memory/128G SSD/COM port*6/USB3.0*1+USB2.0*7/Gigabit LAN port*2/VGA*1/HDMI*1/DVI*1/GPIO*1/Line-out*1/MIC*1/Line-in*1/12V DC power supply/12V power adapter*1/Al-alloy panel/resistive touch screen
0010-174551	P17-92	17" Panel PC/Intel® H110 chipset/I5-7500T 2.7Ghz quad-core processor/8GB memory/128G SSD/COM port*6/USB2.0*4+USB3.0*4/Gigabit LAN port*2/VGA port*1/HDMI*1/DVI*1/8-bit GPIO*1/Line-out*1/MIC*1/Line-in*1/19V DC power supply/19V power adapter*1/Al-alloy panel/resistive touch screen
0010-174561	P17-93	17" Panel PC/Intel® C236 chipset/I7-8700 3.2Ghz six-core processor/8GB memory/128G SSD/COM port*5/USB3.0*8/Gigabit LAN port*4/VGA*1/HDMI*1/DVI*1/GPIO*1/Line-out*1/MIC*1/Line-in*1/19V DC power supply/19V power adapter*1/Al-alloy panel/resistive touch screen

Note: The final interpretation rights for product specifications, ordering information, etc. belong to EVOC Intelligent Technology Co., Ltd.

D15

15" Square-screen Industrial Panel PC

D15 series is a 15" full-plane square-screen industrial display, supporting three standard display port input, i.e., VGA, DVI and HDMI, OSD function, touch screen operation, mounting methods including panel type, wall mount and VESA standard arm. This product targets high-end MES, comprehensive monitoring, equipment control and other fields, and is mainly used in production line MES, comprehensive monitoring (rail transit, buildings, power, etc.), CNC, single crystal furnace machines, auto parts control, forming machines, etc.



Product Features



Full-plane



Three Display Input



Multiple mounting methods



Protection grade IP65

Product Dimensions Drawing

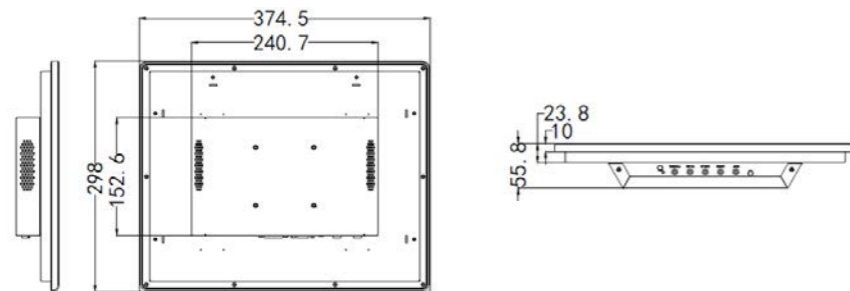

Please refer to the user manual to check detailed specifications and dimension. (Unit: MM)

Product Specifications

Item		Description	
Display Performance	Screen Size	15" 4:3 square-screen	Frequency 60Hz-75Hz
	Maximum Resolution	1024x768	Pixel Pitch 0.297mm×0.297mm
	Brightness	300cd/m ²	Display Color 16.2M color
	Contrast Ratio	600:1	Viewing Angle CR≥10
Touch Screen	Full-plane 5-wire resistance (USB signal)		
Display Function	Supports three standard port input: VGA, HDMI, DVI		
External I/O Ports	1 x Type-B USB input port (used for touch screen) 1 x VGA input port 1 x HDMI input port 1 x DVI input port 1 x LINE IN input port		
Speaker	2 x 8Ω 3W speaker		
OSD Menu	Brightness, contrast ratio, automatic correction, function settings, reset, etc.		
Mechanical Environmental Adaptability	Anti-vibration performance in working: frequency 5-15Hz, amplitude 1mm; frequency 15-200Hz, acceleration 1.0g Shock: 15g acceleration, 11ms duration		
Safety	Meets basic requirements of GB4943-2011		
Reliability	MTBF≥50000h MTTR≤0.5h		
EMC	GB 9254-2021 radiated emission class (A) GB 9254-2021 conducted emission class (A) GB/T 17626.2-2018 electrostatic discharge level (2); GB/T 17626.4-2018 burst immunity level (2) GB/T 17626.5-2019 surge (shock) immunity level (2) GB/T 17626.6-2017 conducted immunity level (2)		
Working Environment	-5°C ~ +55°C		
Storage Environment	-20°C~+65°C		
Dimensions	374.5mm (width)×298mm (height)×55.8mm (depth)		
Mounting Dimensions	350.5mm (width)×274mm (height)		
Protection Grade	The front panel meets IP65 grade		
Mounting Method	Embedded type, VESA standard arm (75mm*75mm)		
Weight	About 4Kg (excluding package and accessories)		
Power Supply	Input voltage/frequency: 220VAC/50Hz (with adapter) Input voltage: 12VDC (no adapter, direct input to the PC)		

Ordering Information

Part No.	Description	Specifications
0010-118061	D15-01	15" full-plane, industrial-grade panel display (1024*768), with touch screen, OSD function, VGA, HDMI and DVI input ports, protection grade of front panel IP65, and external power adapter for power supply

Note: The final interpretation rights for product specifications, ordering information, etc. belong to EVOC Intelligent Technology Co., Ltd.

D17

17" Square-screen Industrial Panel PC

D17 series is a 17" full-plane square-screen industrial display, supporting three standard display port input, i.e., VGA, DVI and HDMI, OSD function, touch screen operation, mounting methods including panel type, wall mount and VESA standard arm. This product targets high-end MES, comprehensive monitoring, equipment control and other fields, and is mainly used in production line MES, comprehensive monitoring (rail transit, buildings, power, etc.), CNC, single crystal furnace machines, auto parts control, forming machines, etc.



Product Features



Full-plane



Three Display Input



Multiple mounting methods



Protection grade IP65

Product Dimensions Drawing

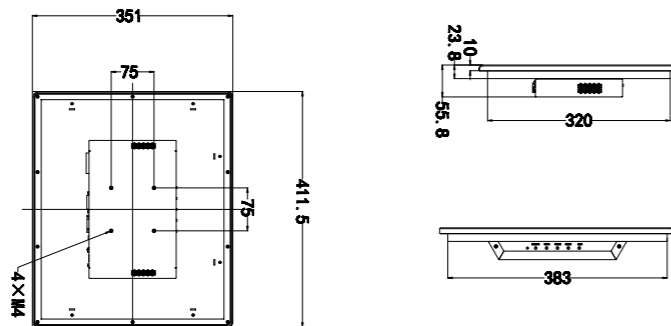

Please refer to the user manual to check detailed specifications and dimension. (Unit: MM)

Product Specifications





Item		Description		
Display Performance	Screen Size	17" 5:4 square-screen	Frequency	60Hz-75Hz
	Maximum Resolution	1280x1024	Pixel Pitch	0.264mm×0.264mm
	Brightness	250cd/m ²	Display Color	16.7M color
	Contrast Ratio	1000:1	Viewing Angle	CR≥10
Touch Screen	Full-plane 5-wire resistance (USB signal)			
Display Function	Supports three standard port input: VGA, HDMI, DVI			
External I/O Ports	1 x Type-B USB input port (used for touch screen) 1 x VGA input port 1 x HDMI input port 1 x DVI input port 1 x LINE IN input port			
Speaker	2 x 8Ω 3W speaker			
OSD Menu	Brightness, contrast ratio, automatic correction, function settings, reset, etc.			
Mechanical Environmental Adaptability	Anti-vibration performance in working: frequency 5-15Hz, amplitude 1mm; frequency 15-200Hz, acceleration 1.0g Shock: 15g acceleration, 11ms duration			
Safety	Meets basic requirements of GB4943-2011			
Reliability	MTBF≥50000h MTTR≤0.5h			
EMC	GB 9254-2021 radiated emission class (A) GB 9254-2021 conducted emission class (A) GB/T 17626.2-2018 electrostatic discharge level (2); GB/T 17626.4-2018 burst immunity level (2) GB/T 17626.5-2019 surge (shock) immunity level (2) GB/T 17626.6-2017 conducted immunity level (2)			
Working Environment	-5°C ~ +55°C			
Storage Environment	-20°C~+65°C			
Dimensions	411.5mm (width)×351mm (height)×55.8mm (depth)			
Mounting Dimensions	386.6mm (width)×323.6mm (height)			
Protection Grade	The front panel meets IP65 grade			
Mounting Method	Embedded type, VESA standard arm (75mm*75mm)			
Weight	About 4.85Kg (excluding package and accessories)			
Power Supply	Input voltage/frequency: 220VAC/50Hz (with adapter) Input voltage: 12VDC (no adapter, direct input to the PC)			

Ordering Information

Part No.	Description	Specifications
0010-118071	D17-01	17" full-plane, industrial-grade panel display (1280*1024), with touch screen, OSD function, VGA, HDMI and DVI input ports, protection grade of front panel IP65, and external power adapter for power supply



Note: The final interpretation rights for product specifications, ordering information, etc. belong to EVOC Intelligent Technology Co., Ltd.

Industrial control computer selection guide

Model	IPC-520S	IPC-620H	IPC-6207	IPC-810E
Product Picture				
Motherboard	EC7 series	Non-standard ECS series	ECO series	ECO/EPE series
I/O Ports	Depends on different motherboard configurations			
Storage	1 x 2.5" shock-absorption hard disk bay	1 x 2.5" shock-absorption hard disk bay, 1 x ultra-thin optical drive bay	2 x 3.5" shock-absorption hard disk bay	1 x 5.25" CD-ROM space 2 x 3.5" HDD space (with shock-absorption)
Working Environment	0°C~50°C, 5%~90% (non-condensing)			
Storage Environment	-20°C~60C, 5%~90%(non-condensing)	-20°C~60C, 5%~90%(non-condensing)	-20°C~80C, 5%~90%(non-condensing)	-20°C~60C, 5%~90% (non-condensing)
Powr Supply	MiniATX industrial-grade power supply	Small size PS2 ATX power supply or 1U small power supply	1U small power supply	Standard ATX power supply
Dimensions (W×H×D)	250mm×210mm×88mm	280mm×165mm×238mm	380mm×164mm×316mm	482 mm×177 mm×470.4 mm

Note: The final interpretation rights for product specifications, ordering information, etc. belong to EVOC Intelligent Technology Co., Ltd.

Industrial control computer selection guide

Model	IPC-820	IPC-860	MGP-800
Product Picture			
Motherboard	ECO/EPE series	ECO/EPE/SVE series	Non-standard ECS series
I/O Ports	Depends on different motherboard configurations		
Storage	1 x 5.25" CD-ROM space 2 x 3.5" HDD space (with shock-absorption)	Supports two types of hard disk modules: 4 x 3.5" pull-out type hard disk (without shock absorption) 2 x 3.5" pull-out type hard disk shock absorption	The expansion box has 2 x 2.5" hard disk pull-out bay The expansion box supports 1 x built-in 2.5" hard disk expansion bay (optional)
Working Environment	0°C~50°C, 5%~90% (non-condensing)	"ECO/EPE configuration: 0°C~50°C, 5%~90% (non-condensing) EATX server configuration: 0°C~40°C, 5%~90% (non-condensing)"	Processors with different power consumption require different working environments
Storage Environment	-20°C~60C, 5%~90% (non-condensing)	-20°C~60C, 5%~90% (non-condensing)	-40°C~85C, 95% @40°C (non-condensing)
Powr Supply	Standard ATX power supply	Standard ATX power supply/redundant power supply	External power supply
Dimensions (W×H×D)	482 mm×177 mm×470.4 mm	482 mm×177 mm×552 mm	Dimensions of PC with dual GPU expansion: 290mm×200mm×395mm Dimensions of PC with single GPU expansion: 229mm×200mm×395mm

Note: The final interpretation rights for product specifications, ordering information, etc. belong to EVOC Intelligent Technology Co., Ltd.

IPC-520S

Small and Compact Wall Mount chassis

IPC-520S is a small and compact PC, which is made of sheet metal material, and has excellent heat dissipation and vibration resistance. It can be equipped with an EC7 series motherboard. The H110/C236 platform motherboard supports 6/7th-generation series processors having Intel LGA 1151 pins, supports full-height and half-length expansion cards, and has excellent expansibility, so the product can be installed in a narrow space. It can be widely used in industries such as industrial manufacturing, machine vision, and security inspection.



Product Features



Small size



Multi-expansion



Multiple IO ports

Product Dimensions Drawing

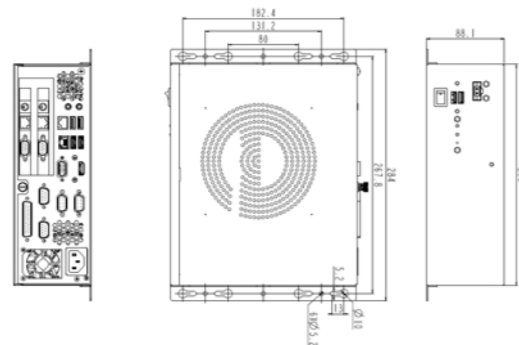

Please refer to the user manual to check detailed specifications and dimension. (Unit: MM)

Product Specifications

Item	Description
Motherboard	Supports Mini-ITX motherboard
Chipset	Intel H110/C236 platform chipset
CPU	Supports Intel LGA 1151 pin 6/7th-generation processors
Memory	1 x DDR4 U-DIMM slot, supporting up to 16G memory capacity
I/O ports	Rear: 2 x USB3.0, 2 x USB2.0 4 x COM, COM1, COM2 support RS232\RS422\RS485 1 x VGA, 1 x HDMI 2 x Gigabit LAN port 1 x ATX power socket 1 x LINE-IN, 1 x LINE-OUT 1 x 16-bit GPIO, brought out via lead wire by means of DB44 Front: 2 x USB2.0 port Power switch at front Phoenix terminal connector used for connecting power supply at front
Storage	1 x 2.5" shock-absorption hard disk bay, not support, optical drive installation
Bus Expansion	1 x PCIe*16
Working Environment	0°C~50°C, 5%~90%(non-condensing)
Storage Temperature	-20°C~60°C, 5%~90%(non-condensing)
Power supply	MiniATX industrial-grade power supply
Operating System	WIN7, WIN8, WIN10, LINUX
Dimensions (W×H×D)	250mm×210mm×88mm

Ordering Information

Part No.	Model	Description
0010-114851	IPC-520S-01	EC7-1821-H110 motherboard/I3-6100/4G memory/500G HDD/ATX 200W power supply/no optical drive, no keyboard and mouse/2 x LAN port, 6 x COM port (4 external ports on the chassis; 2 motherboard pins), VGA+HDMI dual display, 6 x USB/1 x LINE-IN, 1 x LINE-OUT/1 x 16-channel GPIO pin brought out via lead wire by means of DB44/1 x PCIe*16 (heat dissipation holes at the top of the chassis)
0010-114861	IPC-520S-02	EC7-1821-H110 motherboard/I5-6500/4G memory/1T HDD/ATX 200W power supply/no optical drive, no keyboard and mouse/2 x LAN port, 6 x COM port (4 external ports on the chassis; 2 motherboard pins), VGA+HDMI dual-display, 6 x USB/1 x LINE-IN, 1 x LINE-OUT/1 x 16-channel GPIO pin brought out via lead wire by means of DB44/1 x PCIe*16 (heat dissipation holes at the top of the chassis)
0010-062731	IPC-520S barebone system	EC7-1821-H110-01 motherboard/no CPU/no memory/no hard disk/ATX 200W power supply/no optical drive, no keyboard and mouse/2 x LAN port, 6 x COM port (4 external ports on the chassis; 2 motherboard pins), VGA+HDMI dual display, 6 x USB/1 x LINE-IN, 1 x LINE-OUT/1 x 16-channel GPIO pin brought out via lead wire by means of DB44/1 x PCIe*16 (no heat dissipation hole at the top of the chassis) Note: Axial fan heat sink is used, and this configuration does not support insertion of an expansion card
0020-062741	IPC-520S-01 barebone system	EC7-1821-C236 motherboard/no CPU/no memory/no hard disk/ATX 200W power supply/no optical drive, no keyboard and mouse/2 x LAN port, 6 x COM port (4 external ports on the chassis; 2 motherboard pins), VGA+HDMI duan display, 6 x USB/1 x LINE-IN, 1 x LINE-OUT/1 x 16-channel GPIO pin brought out via lead wire by means of DB44/1 x PCIe*16 (heat dissipation holes at the top of the chassis)

Optional Accessories

Part No.	Model	Description
0060-005061	2*PCI expansion board	Full-height half-length expansion card used for expanding PCI port
0060-005051	PCIe*16 expansion board	Full-height half-length expansion card used for expanding PCIe*16 port
0090-005271	2*PCIe*8 expansion board(EB-X16-200B)	Full-height half-length expansion card used for expanding PCIe*8 port, used together with a C236 platform motherboard
0090-005281	1*PCIe*8+1*PCI expansion board(EB-X16-110B)	Full-height half-length expansion card used for expanding PCIe*8+PCI ports, used together with a C236 platform motherboard

Note: The final interpretation rights for product specifications, ordering information, etc. belong to EVOC Intelligent Technology Co., Ltd.

IPC-620H

Small and Compact Wall Mount chassis

IPC-620H is a small and compact wall mount chassis, equipped with the ECS series specific motherboards, supporting platform motherboards such as H81, H110, and H310. The product features compact size, high performance, and high cost-effectiveness, and has multiple IO ports and excellent expansibility in a small form factor. The chassis adopts a miniaturized design, which can meet the installation requirements in narrow spaces. Its main application areas include 3C manufacturing, machine vision, security inspection, highways and self-service terminals.



Product Features



Small size
strong expansibility



Flip type
easy maintenance



Multiple IO ports

Product Dimensions Drawing

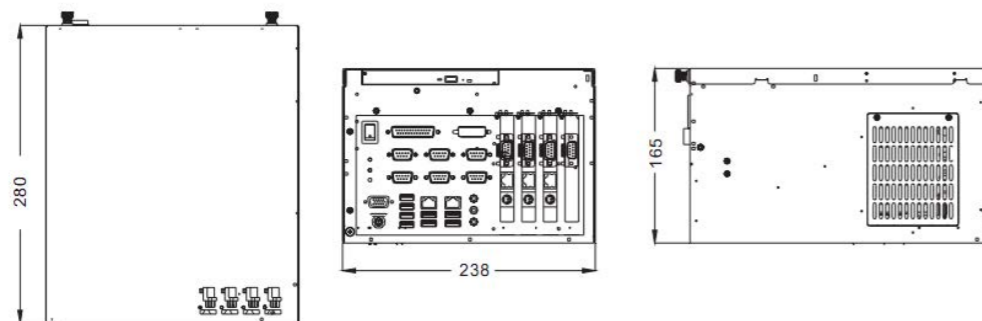

Please refer to the user manual to check detailed specifications and dimension. (Unit: MM)

Product Specifications

Item	Description
Motherboard	ECS-specific motherboard: H81 platform ECS-1830; H110 platform ECS-1839; H310 platform ECS-1852
Storage	1 x 2.5" hard disk shock absorption bay; 1 x ultra-thin optical drive bay (supports 1 x 2.5" hard disk installation)
I/O Ports	All the IO ports are located on one side, and details depend on different motherboard platforms
Power Supply	Small size PS2 ATX power supply or 1U small power supply
Working Temperature	0°C~50°C, 5%~90%(non-condensing)
Storage Temperature	-20°C~60°C, 5%~90%(non-condensing)
Dimensions (W×H×D)	280mm×165mm×238mm

Ordering Information

Part No.	Model	Description
0020-061151	IPC-620H/ECS-1830/250W/barebone system	H81 platform motherboard/250W/6 x COM, 2 x USB3.0, 6 x USB2.0, 2 x LAN port, VGA+DVI-D, 1 x LPT, 1 group of audio ports, 1 x PS2, expansion: 2 x PCI+1 x PCIE4+1 x PCIE16
0020-065441	IPC-620H/ECS-1830-NS/250W	H81 platform motherboard/250W/6 x COM, 2 x USB3.0, 6 x USB2.0, 2 x LAN port, VGA+DVI-D, 1 x LPT, no sound card, 1 x PS2, expansion: 2 x PCI+1 x PCIE4+1 x PCIE16
0010-088461	IPC-620H-03/I3-4330-2G-500G-300W-no optical drive	H81 platform motherboard/I3-4330/2G memory/500G HDD/300W power supply/6 x COM, 2 x USB3.0, 8 x USB2.0, 2 x LAN port, VGA+DVI-D, 1 x LPT, 1 group of audio ports, 1 x PS2, expansion: 2 x PCI+1 x PCIE4+1 x PCIE16
0010-120321	IPC-620H-04/I5-4590S-4G-1TB-300W-no optical drive	H81 platform motherboard/I5-4590S/4G memory/1TB hard disk/300W power supply/6 x COM, 2 x USB3.0, 8 x USB2.0, 2 x LAN port, VGA+DVI-D, 1 x LPT, 1 group of audio ports, 1 x PS2, expansion: 2 x PCI+1 x PCIE4+1 x PCIE16
0020-062121	IPC-620H barebone system/ECS-1839/250W	H110 platform motherboard/250W power supply/2 x COM, 4 x USB3.0, 4 x USB2.0, 2 x LAN port, VGA+HDMI, 1 x LPT, 1 group of audio ports, expansion: 2 x PCI+1 x PCIE4+1 x PCIE16
0020-065431	IPC-620H/ECS-1839-NS/250W	H110 platform motherboard/250W power supply/2 x COM, 4 x USB3.0, 4 x USB2.0, 2 x LAN port, VGA+HDMI, 1 x LPT, no sound card, expansion: 2 x PCI+1 x PCIE4+1 x PCIE16
0010-106041	IPC-620H/ECS-1839/G3900/4G/500G/250W	H110 platform motherboard/G3900/4G memory/500G HDD/250W power supply/6 x COM, 4 x USB3.0, 4 x USB2.0, 2 x LAN port, VGA+HDMI, 1 x LPT, 1 group of audio ports, expansion: 2 x PCI+1 x PCIE4+1 x PCIE16
0010-106051	IPC-620H/ECS-1839/I3-6100/4G/500G/250W	H110 platform motherboard/I3-6100/4G memory/500G HDD/250W power supply/6 x COM, 4 x USB3.0, 4 x USB2.0, 2 x LAN port, VGA+HDMI, 1 x LPT, one group of audio ports, expansion: 2 x PCI+1 x PCIE4+1 x PCIE16
0010-106061	IPC-620H/ECS-1839/I5-6500/4G/1T/250W	H110 platform motherboard/I5-6500/4G memory/1T HDD/250W power supply/6 x COM, 4 x USB3.0, 4 x USB2.0, 2 x LAN port, VGA+HDMI, 1 x LPT, 1 group of audio ports, expansion: 2 x PCI+1 x PCIE4+1 x PCIE16
0010-106071	IPC-620H/ECS-1839/I7-6700/8G/1T/250W	H110 platform motherboard/I7-6700/8G memory/1T HDD/250W power supply/6 x COM, 4 x USB3.0, 4 x USB2.0, 2 x LAN port, VGA+HDMI, 1 x LPT, 1 group of audio ports, expansion: 2 x PCI+1 x PCIE4+1 x PCIE16
0020-065471	IPC-620H/ECS-1852/250W	H310 platform motherboard/supports Intel® 8th/9th LGA1151 pin series processors, TDP maximum power consumption 95W/supports two DDR4 memory modules, supporting up to 64G/250W power supply/2 x COM, VGA+HDMI, 4 x USB3.1, 4 x USB2.0, 2 x RJ45, 1 group of audio ports; expansion: 2 x PCI+1 x PCIE4+1 x PCIE16
0010-152231	IPC-620H/ECS-1852/G4900/4G/128G/250W	H310 platform motherboard/G4900/4G memory/128G SSD/250W power supply/6 x COM, VGA+HDMI, 4 x USB3.1, 4 x USB2.0, 2 x RJ45, 1 x LPT, 1 group of audio ports; expansion: 2 x PCI+1 x PCIE4+1 x PCIE16
0010-152241	IPC-620H/ECS-1852/I3-8100/4G/128G/250W	H310 platform motherboard/I3-8100/4G memory/128G SSD/250W power supply/6 x COM, VGA+HDMI, 4 x USB3.1, 4 x USB2.0, 2 x RJ45, 1 x LPT, 1 group of audio ports; expansion: 2 x PCI+1 x PCIE4+1 x PCIE16
0010-152251	IPC-620H/ECS-1852/I5-8500/8G/1T/250W	H310 platform motherboard/I5-8500/8G memory/1T HDD/250W power supply/6 x COM, VGA+HDMI, 4 x USB3.1, 4 x USB2.0, 2 x RJ45, 1 x LPT, 1 group of audio ports; expansion: 2 x PCI+1 x PCIE4+1 x PCIE16
0010-152261	IPC-620H/ECS-1852/I7-8700/8G/1T/250W	H310 platform motherboard/I7-8700/8G memory/1T HDD/250W power supply/6 x COM, VGA+HDMI, 4 x USB3.1, 4 x USB2.0, 2 x RJ45, 1 x LPT, 1 group of audio ports; expansion: 2 x PCI+1 x PCIE4+1 x PCIE16

Note: The final interpretation rights for product specifications, ordering information, etc. belong to EVOC Intelligent Technology Co., Ltd.

IPC-6207

Seven-slot Compact Wall Mount chassis

IPC-6207 is a 7-slot compact wall mounted PC, equipped with EC0/ECS series motherboards. It has excellent expansibility with a compact size, and supports 7 expansion slots. All of its IO ports are located at the same side, which makes operation convenient. The product features compact size, high performance, and multiple IO ports. It mainly targets the intelligent manufacturing industry, and can be used in such fields as 3C manufacturing, machine vision, security inspection, highways, and self-service terminals.



Product Features



Supports multiple platforms



All IO ports are located at the same side

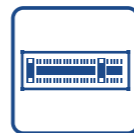

7 expansion slots

Product Dimensions Drawing

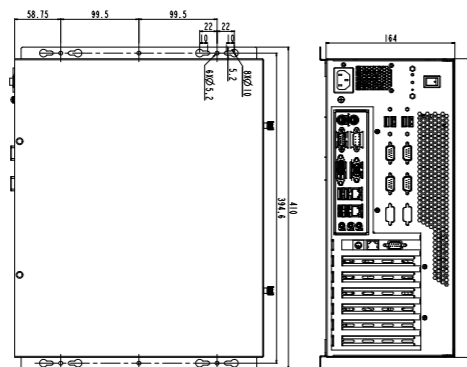

Please refer to the user manual to check detailed specifications and dimension. (Unit: MM)

Product Specifications

Item	Description
Motherboard	Supports EC0/ECS series motherboards
Storage	2 x 3.5" hard disk shock-absorption bay
I/O Ports	Power switch, reset switch, power and hard disk indicators
Power Supply	1U small power supply
Working Temperature	0°C~50°C, 5%~90%(non-condensing)
Storage Temperature	-20°C~80°C, 5%~90%(non-condensing)
Dimensions (W×H×D)	380mm×164mm×316mm Supported expansion card length ≤270mm

Ordering Information

Part No.	Model	Description
0020-066461	IPC-6207/EC0-1816/250W	"H61 platform motherboard/250W power supply/2 x COM, 6 x USB(2 at front and 4 at rear), 2 x Gigabit LAN port, VGA+DVI-D, 1 group of audio ports, 1 x PS2, expansion:4 x PCI+1 x PCIEX4+1 x PCIEX16 Note:because PCIE X4 slot and LAN2 share a same resource, when PCIE X4 card is inserted, LAN2 does not function."
0020-066451	IPC-6207/EC0-1817/250W	H81 platform motherboard/250W power supply/2 x COM, 6 x USB(2 at front and 4 at rear), 2 x Gigabit LAN port, VGA+DVI-D, 1 group of audio ports, 1 x PS2, expansion:4 x PCI+2 x PCIEX1+1 x PCIEX16
0020-066441	IPC-6207/EC0-1818/250W	H110 platform motherboard/250W power supply/2 x COM, 6 x USB(2 at front and 4 at rear), 2 x Gigabit LAN port, VGA+HDMI, 1 group of audio ports, 1 x PS2, expansion:4 x PCI+1 x PCIEX4+1 x PCIEX16
0020-066761	IPC-6207/EC0-1818-C236/250W	C236 platform motherboard/250W power supply/2 x COM, 6 x USB(2 at front and 4 at rear), 2 x Gigabit LAN port, supports any three display ports (VGA, HDMI, DVI-D, DP), 1 group of audio ports, 1 x PS2, expansion:2 x PCI+3 x PCIEX4 (X8 connector) +2 x PCIEX16 (see the manual for details)
0020-066431	IPC-6207/EC0-1820/250W	H310 platform motherboard/250W power supply/2 x COM, 6 x USB(2 at front and 4 at rear), 2 x Gigabit LAN port, any 2 display ports among 4 (VGA, HDMI, DVI-D, DP), 1 group of audio ports, expansion:5 x PCI+1 x PCIEX4, 1 x PCIEX16
0010-143531	IPC-6207/ECO-1816/i5-3550/4G/1T/250W	"H61 platform motherboard/i5-3550/4G memory/1T HDD/250W power supply/6 x COM, 8 x USB, 2 x Gigabit LAN port, VGA+DVI-D, 1 group of audio ports, 1 x PS2, expansion:4 x PCI+1 x PCIEX4+1 x PCIEX16 Note: because PCIE X4 slot and LAN2 share a same resource, when PCIE X4 card is inserted, LAN2 does not function."
0010-143541	IPC-6207/ECO-1817/i5-4570/4G/1T/250W	H81 platform motherboard/i5-4570/4G memory/1T HDD/250W power supply/6 x COM, 8 x USB, 2 x Gigabit LAN port, VGA+DVI-D, 1 group of audio ports, 1 x PS2, expansion:4 x PCI+2 x PCIEX1+1 x PCIEX16

Note: The final interpretation rights for product specifications, ordering information, etc. belong to EVOC Intelligent Technology Co., Ltd.

IPC-810E

4U Standard Rack Mount chassis

IPC-810E is a 4U rack mount chassis made of high-quality steel sheet. It supports various full-length cards and industrial motherboards of the company, such as EPE, EC9 and EC0 series. It has a reasonable structure, and can be equipped with one 5.25" CD-ROM and two 3.5" shock absorption hard disk bay. The product can be widely used in various fields such as communication, network, finance, power, transportation and industrial automation.



Product Features



4U standard rack mount

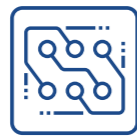

Supports multiple motherboards

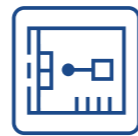

Super EMC performance

Product Dimensions Drawing

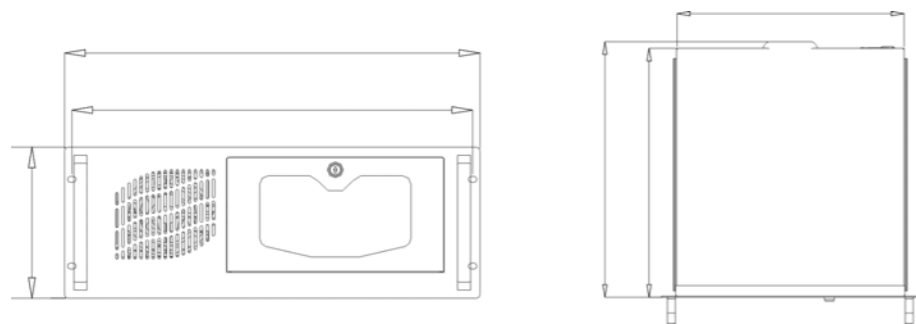

Please refer to the user manual to check detailed specifications and dimension. (Unit: MM)

Product Specifications

Item	Description
Motherboard	PICMG 1.0, PICMG 1.3, EPI 2.0 and EPE standard full-size boards, ATX motherboard
Backplane	10-slot standard PICMG 1.0 backplane, 14-slot standard PICMG 1.0 backplane, 10-slot standard PICMG 1.3 backplane, 13-slot standard EPI 2.0 backplane and 10-slot EPE backplane.
Storage	1 x 5.25" CD-ROM bay, 2 x 3.5" hard disk shock-absorption bay
I/O Ports	Power switch, reset switch, power supply and hard disk indicators; 2 x USB port at front
Power Supply	Standard ATX power supply
Working Temperature	0°C~50°C, 5%~90%(non-condensing)
Storage Temperature	-20°C~60°C, 5%~90%(non-condensing)
Dimensions (W×H×D)	482 mm × 177 mm × 470.4 mm

Ordering Information

Part No.	Model	Description
0020-063911	IPC-810/ECO-1816/250W	H61 platform motherboard/250W power supply/VGA+DVI-D, 2 x Gigabit LAN port, 6 x USB(2 at front, 4 at rear), 2 x COM, 1 group of audio ports, 1 x PS2, expansion:4 x PCI, 1 x PCIEX4, 1 x PCIEX16 Note:because PCIE X4 slot and LAN2 share a same resource, when PCIE X4 card is inserted, LAN2 does not function.
0010-140561	IPC-810E/ECO-1816/G1620/2G/1T/250W	H61 platform motherboard/G1620/2G memory/1T HDD/250W power supply/VGA+DVI-D, 2 x Gigabit LAN port, 6 x USB(2 at front, 4 at rear), 6 x COM port, 1 group of audio ports, 1 x PS2, 1 x LPT; expansion:4 x PCI, 1 x PCIEX4, 1 x PCIEX16 Note:because PCIE X4 slot and LAN2 share a same resource, when PCIE X4 card is inserted, LAN2 does not function.
0020-061221	IPC-810/ECO-1816/no CPU/2G/1T/250W	H61 platform motherboard/2G memory/1T HDD/250W power supply/VGA+DVI-D, 2 x Gigabit LAN port, 6 x USB(2 at front, 4 at rear), 6 x COM port, 1 group of audio ports, 1 x PS2, 1 x LPT; expansion:5 x PCI, 1 x PCI-E*1 (PCI-E*4 slot), 1 x PCI-E*16 expansion slot
0020-061731	IPC-810/ECO-1817-6COM/250W	H81 platform motherboard/250W memory/2 x COM, 2 x Gigabit LAN port, 6 x USB(2 at front, 4 at rear), VGA+DVI-D, 1 group of audio ports, 1 x PS2, 1 x LPT, expansion:4 x PCI, 2 x PCIEX1 (PCIEX4 slot), 1 x PCIEX16
0010-098891	IPC-810E/ECO1817-6COM/G1820/2G/1T/250W	H81 platform motherboard/G1820/2G memory/1T HDD/250W power supply/6 x COM, 2 x Gigabit LAN port, 6 x USB(2 at front, 4 at rear), VGA+DVI-D, 1 group of audio ports, 1 x PS2, 1 x LPT, expansion:4 x PCI, 2 x PCIEX1 (PCIEX4 slot), 1 x PCIEX16
0020-063431	IPC-810/ECO-1818(C)/250W power supply	H110 platform motherboard/250W power supply/2 x COM, 2 x Gigabit LAN port, 6 x USB(2 at front, 4 at rear), VGA+HDMI, 1 group of audio ports, 1 x PS2, 1 x LPT, expansion:4 x PCI, 1 x PCIEX4, 1 x PCIEX16
0010-127031	IPC-810E/ECO-1818(C)/G3900/4G/1T/250W	H110 platform motherboard/G3900/2G memory/1T HDD/250W power supply/6 x COM, 2 x Gigabit LAN port, 6 x USB(2 at front, 4 at rear), VGA+HDMI, 1 group of audio ports, 1 x PS2, 1 x LPT, expansion:4 x PCI, 1 x PCIEX4, 1 x PCIEX16
0020-064471	IPC-810/ECO-1820(B)/250W	H310 platform motherboard/250W power supply/2 x COM, 2 x Gigabit LAN port, 6 x USB(2 at front, 4 at rear), any two display ports among four (VGA, HDMI, DVI-D, DP), 1 group of audio ports, 1 x PS2, expansion:5 x PCI, 1 x PCIEX4, 1 x PCIEX16
0020-065321	IPC-810/ECO-1820(B)-NS/250W	H310 platform motherboard/250W power supply/2 x COM, 2 x Gigabit LAN port, 6 x USB(2 at front, 4 at rear), any two display ports among four (VGA, HDMI, DVI-D, DP), no sound card, 1 x PS2, expansion:5 x PCI, 1 x PCIEX4, 1 x PCIEX16
0010-140681	IPC-810E/ECO-1820(B)/G4900/4G/1TB/250W	H310 platform motherboard/G4900/4G memory/1T HDD/250W power supply/6 x COM, 2 x Gigabit LAN port, 6 x USB(2 at front, 4 at rear), any two display ports among four (VGA, HDMI, DVI-D, DP), 1 group of audio ports, 1 x PS2, expansion:5 x PCI, 1 x PCIEX4, 1 x PCIEX16
0020-064981	IPC-810/ECO-1821/300W	C246 platform motherboard/300W power supply/2 x COM/2 x Gigabit LAN port/8 x USB(2 at front, 6 at rear)/any three display ports among four (VGA, HDMI, DVI-D, DP), 1 group of audio ports; expansion:2 x PCI, 3 x PCIe x4, 2 x PCIe x16; 1 x M.2 KEY M port (PCIe X4, supporting sizes 2242/2260/2280/22110); 1 x M.2 KEY E port (PCIe X1, supporting size 2230)Note:When two PCIe*16 slots are inserted at same time, the speed of PCIe*8 will be reduced
0010-151371	IPC-810E/ECO-1821/I7-8700/8G/1T/300W	C246 platform motherboard/I7-8700/8G memory/1T HDD/300W power supply/6 x COM/2 x Gigabit LAN port/8 x USB(2 at front, 6 at rear)/any three display ports among four (VGA, HDMI, DVI-D, DP), 1 group of audio ports; expansion:2 x PCI, 3 x PCIe x4, 2 x PCIe x16; 1 x M.2 KEY M port (PCIe X4, supporting sizes 2242/2260/2280/22110); 1 x M.2 KEY E port (PCIe X1, supporting size 2230)Note:When two PCIe*16 slots are inserted at same time, the speed of PCIe*8 will be reduced
0020-065581	IPC-810/ECO-1822/300W/barebone system	H420E platform motherboard/300W power supply/2 x COM, 8 x USB(2 at front, 6 at rear), 2 x Gigabit LAN port, VGA+DP, 1 group of audio port, expansion:4 x PCI, 2 x PCIEX4 (actually providing the speed of X1), 1 x PCIEX16
0010-153571	IPC-810E/ECO-1822/I5-10500E/8G/1T/300W	H420E platform motherboard/I5-10500E/8G memory/1T HDD/300W power supply/6 x COM, 8 x USB(2 at front, 6 at rear), 2 x Gigabit LAN port, VGA+DP, 1 group of audio port, expansion:4 x PCI, 2 x PCIEX4 (actually providing the speed of X1), 1 x PCIEX16
0020-066471	IPC-810/ECO-1823-03/300W	Q470E platform motherboard/300W power supply/1 x COM, 10 x USB(2 at front, 8 at rear), 2 x Gigabit LAN port, VGA+DP+DVI-D, 1 group of audio port, expansion:2 x PCI, 2 x PCIe x16, 3 x PCIe x4 Note:When two PCIe*16 slots are inserted at same time, the speed of PCIe*8 will be reduced"
0010-169231	IPC-810E/ECO-1823-03/I5-10500/8G/1T/300W	Q470E platform motherboard/I5-10500/8G memory/1T HDD/300W power supply/6 x COM, 10 x USB(2 at front, 8 at rear), 2 x Gigabit LAN port, VGA+DP+DVI-D, 1 group of audio ports, expansion:2 x PCI, 2 x PCIe x16, 3 x PCIe x4 Note:When two PCIe*16 slots are inserted at same time, the speed of PCIe*8 will be reduced"
0020-059051	IPC-810 barebone/EPE-1815V2NA-H61/250W power supply	H61 platform motherboard/250W power supply/EPE-6110E5(V)(4 x PCI, 4 x PCI-E x1 (actually only 2 can be used), 1 x PCI-E x16)/2 x LAN port, 1 x VGA, 4 x USB(2 at front, 2 at rear), 2 x COM, 1 x LPT, 1 x Audio (accessories), 1 x PS2
0010-083531	IPC-810E/EPE-1815/G1620/2G/1T/250W/no optical drive	H61 platform motherboard/G1620/2G memory/1T HDD/250W power supply/EPE-6110E5(V)(4 x PCI, 4 x PCI-E x1 (actually only 2 can be used), 1 x PCI-E x16)/1 x LAN port, 1 x VGA, 4 x USB(2 at front, 2 at rear), 2 x COM, 1 x LPT, 1 x Audio (accessories), 1 x PS2
0020-061441	IPC-810 barebone system/EPE-1816/EPE-6110E5/250W no optical drive	H110 platform motherboard/EPE-1816/250W power supply/EPE-6110E5(V)(4 x PCI, 4 x PCI-E x1 (actually only 2 can be used), 1 x PCI-E x16)/2 x LAN port, DP+VGA, 4 x USB(2 at front, 2 at rear), 2 x COM, 1 x Audio (accessories), 1 x PS2
0020-061451	IPC-810 barebone system/EPE-1816/EPE-6112E5/250W no optical drive	H110 platform motherboard/EPE-1816/250W power supply/EPE-6112E5(6 x PCI, 4 x PCI-E*4, 1 x *16)/2 x LAN port, DP+VGA, 4 x USB(2 at front, 2 at rear), 2 x COM, 1 x Audio (accessories), 1 x PS2
0010-096901	IPC-810E/EPE-1816/I5-6500/4G/500G/300W no optical drive	H110 platform motherboard/EPE-1816/I5-6500/4G memory/500G HDD/ATX 300W power supply/EPE-6112E5(6 x PCI, 4 x PCI-E*4, 1 x *16)/2 x LAN port, DP+VGA, 4 x USB(2 at front, 2 at rear), 2 x COM, 1 x Audio (accessories), 1 x PS2

Note: The final interpretation rights for product specifications, ordering information, etc. belong to EVOC Intelligent Technology Co., Ltd.

IPC-820

4U Standard Rack Mount Chassis

IPC-820 is a 4U rack mount chassis, which supports various full-length cards and industrial motherboards, such as EPE, EC9 and ECO series. It has built-in high-speed air intake fans, excellent heat dissipation, vibration resistance, and EMC performance. Its front panel is shaped by sheet metal, and its chassis body is made of high-quality steel sheet. The integrated lock protection system for the chassis and door panel can prevent unauthorized personnel from invading. It can be widely used in various fields such as communication, network, finance, power, transportation and industrial automation.



Product Features



4U standard rack mount

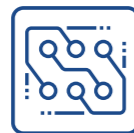

Supports multiple motherboards

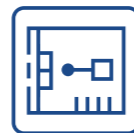

Super EMC performance



Easy replacement of dustproof mesh

Product Dimensions Drawing

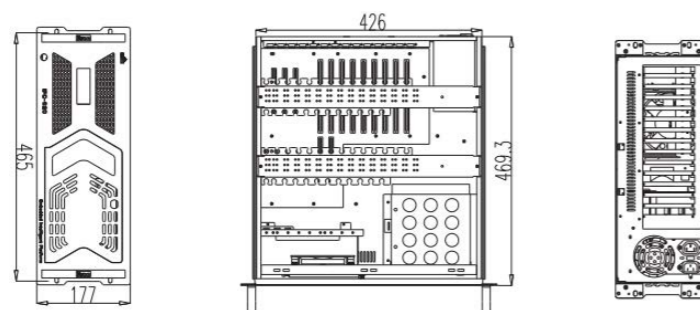

Please refer to the user manual to check detailed specifications and dimension. (Unit: MM)

Product Specifications

Item	Description
Motherboard	PICMG 1.0, PICMG 1.3, EPI 2.0 and EPE standard full-size boards, ATX motherboard
Carrier Board	10-slot standard PICMG 1.0 backplane, 14-slot standard PICMG 1.0 backplane, 10-slot standard PICMG 1.3 backplane, 13-slot standard EPI 2.0 backplane and 10-slot EPE backplane.
Storage	1 x 5.25" CD-ROM bay, 2 x 3.5" hard disk shock-absorption bay
I/O Ports	Power switch, reset switch, power supply and hard disk indicators; 2 x USB port at front
Power Supply	Standard ATX power supply
Working Temperature	0°C~50°C, 5%~90%(non-condensing)
Storage Temperature	-20°C~60°C, 5%~90%(non-condensing)
Dimensions (W×H×D)	482 mm×177 mm×470.4 mm

Ordering Information

Part No.	Model	Description
0010-140551	IPC-820/ECO-1816/G2120/2G/1T/250W	H61 platform motherboard/G2120/2G memory/1T HDD/250W power supply/VGA+DVI-D, 2 x Gigabit LAN port, 6 x USB (2 at front, 4 at rear), 6 x COM port, 1 group of audio ports, 1 x PS2, 1 x LPT; expansion: 4 x PCI, 1 x PCIEX4, 1 x PCIEX16 Note: because PCIE X4 slot and LAN2 share a same resource, when PCIE X4 card is inserted, LAN2 does not function.
0010-098921	IPC-820/EC01817-6COM/G3430/2G/1T/250W	H81 platform motherboard/G3430/2G memory/1T HDD/250W power supply/6 x COM, 6 x USB port (2 at front, 4 at rear), 2 x Gigabit LAN port, VGA+DVI-D, 1 group of audio ports, 1 x PS2, 1 x LPT, expansion: 4 x PCI, 2 x PCIEX1 (PCIEX4 slot), 1 x PCIEX16
0010-127011	IPC-820/ECO-1818(C)/G3900/4G/1T/250W	H110 platform motherboard/G3900/4G memory/1T HDD/250W power supply/6 x COM, 6 x USB port (2 at front, 4 at rear), 2 x Gigabit LAN port, VGA+HDMI, 1 group of audio ports, 1 x PS2, 1 x LPT; expansion: 4 x PCI, 1 x PCIEX4, 1 x PCIEX16
0010-140691	IPC-820/ECO-1820(B)/I7-9700/4G/1TB/300W	H310 platform motherboard/I7-9700/4G memory/1T HDD/300W power supply/6 x COM, 6 x USB (2 at front, 4 at rear), 2 x Gigabit LAN port, any two display ports among four (VGA, HDMI, DVI-D, DP), 1 group of audio ports, 1 x PS2, 1 x LPT, expansion: 5 x PCI, 1 x PCIEX4, 1 x PCIEX16
0010-153581	IPC-820/ECO-1822/i7-10700E/8G/1T/300W	H420E platform motherboard/i7-10700E/8G memory/1T HDD/300W power supply/6 x COM, 8 x USB (2 at front, 6 at rear), 2 x Gigabit LAN port, VGA+DP, 1 group of audio ports, expansion: 4 x PCI, 2 x PCIEX4 (actually providing the speed of X1), 1 x PCIEX16
0010-153591	IPC-820/ECO-1822/i9-10900E/16G/1T/256G	H420E platform motherboard/i9-10900E/16G memory/1T HDD+256G SSD/300W power supply/6 x COM, 8 x USB (2 at front, 6 at rear), 2 x Gigabit LAN port, VGA+DP, 1 group of audio ports, expansion: 4 x PCI, 2 x PCIEX4 (actually providing the speed of X1), 1 x PCIEX16
0010-169241	IPC-820/ECO-1823-03/I7-10700/16G/1T/256G	Q470E platform motherboard/i7-10700/16G memory/1T HDD+256G SSD/300W power supply/6 x COM, 10 x USB (2 at front, 8 at rear), 2 x Gigabit LAN port, VGA+DP+DVI-D, 1 group of audio ports, expansion: 2 x PCI, 2 x PCIE x16, 3 x PCIE x4 Note: When two PCIE *16 slots are used at same time, the speed is reduced to the speed of PCIE*8
0010-072771	IPC-820/EPE-1815-G2120-2G-1T-250W no optical drive	H61 platform motherboard/G2120/2G memory/1T HDD/250W power supply/EPE-6111P6(6 x PCI, 3 x ISA, 1 x PCI-E x 16) /1 x LAN port, 1 x VGA, 4 x USB(2 at front, 2 at rear), 2 x COM, 1 x LPT, 1 x Audio (accessories), 1 x PS2
0010-096921	IPC-820/EPE-1816/I3-6100/4G/500G/300W no optical drive	H110 platform motherboard/I3-6100/4G memory/500G HDD/300W power supply/EPE-6110E5(V)(4 x PCI, 4 x PCI-E x 1 (actually only 2 can be used), 1 x PCI-E x 16) /2 x LAN port, DP+VGA, 1 x PS2, 4 x USB(2 at front, 2 at rear), 2 x COM, 1 x Audio (accessories)
0010-096931	IPC-820/EPE-1816/I5-6500/4G/500G/300W no optical drive	H110 platform motherboard/I5-6500/4G memory/500G HDD/300W power supply/ EPE-6112E5 (6 x PCI, 4 x PCIE*4, 1 x *16) /2 x LAN port, DP+VGA, 1 x PS2, 4 x USB(2 at front, 2 at rear), 2 x COM, 1 x Audio (accessories)
0010-096941	IPC-820/EPE-1816/I7-6700/4G/1T/300W no optical drive	H110 platform motherboard/I7-6700/4G memory/1T HDD/300W power supply/ EPE-6113E2 (10 x PCI, 1 x PCI-E x 1 (x4 slot), 1 x PCI-E x 16) /2 x LAN port, DP+VGA, 1 x PS2, 4 x USB (2 at front, 2 at rear), 2 x COM, 1 x Audio (accessories)

Note: The final interpretation rights for product specifications, ordering information, etc. belong to EVOC Intelligent Technology Co., Ltd.

IPC-860

4U Standard Rack Mount Chassis

The IPC-860 is a 19" 4U rack mount industrial-grade chassis, which is made of high-quality metal steel sheet. Internally, high-power fans are used to directly dissipate heat from the system, providing excellent ventilation and heat dissipation performance. It has 4 x 3.5" pull-out type hard disk module, and is equipped with user interactive display module. It has touch function, and realizes shut-down, information display, status monitoring, process management, log management, etc.

It can be widely used in recording monitoring and surveillance systems of bank security monitoring system, intelligent Building management system (IBMS), integrated security management system (ISMS), integrated traffic management system (ITMS), machine vision, workstation, insurance, securities and other industries.



Product Features

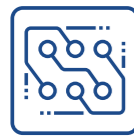

Supports multiple types of motherboards



4 x pull-out hard disk bay



Professional heat dissipation system



LCM interactive module

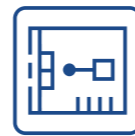

Super EMC performance

Product Dimensions Drawing

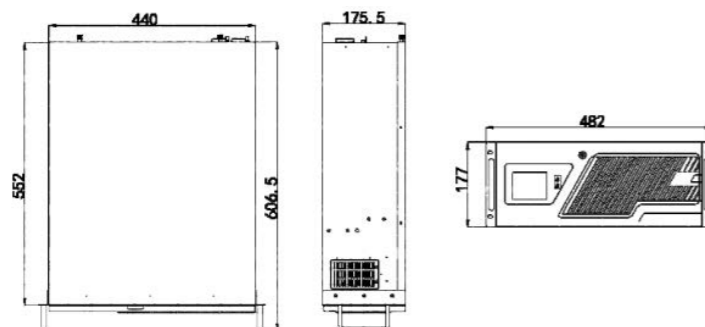

Please refer to the user manual to check detailed specifications and dimension. (Unit: MM)

Product Specifications

Item	Description
Motherboard	EPE full-length card, ATX sing board, EATX server motherboard
Processor	Depends on motherboard: EPE/ECO series motherboard: supports the processors corresponding to H61/H81/H110/C236/H310 platform. SVE-2901 motherboard: supports dual-channel Xeon E5-2600 V3/V4 series processors
Memory	Depends on motherboard: SVE-2901(dual-channel C612): supports 16 x 288PIN DDR4 slot, supporting up to 512GB DDR4 ECC RDIMM EPE/ECO series motherboard:choose the corresponding memory according to the motherboard.
Carrier Board	When an EPE series motherboard is used, it can be paired with 10-13-slot standard EPE carrier board
Storage	Supports two types of hard disk modules: A: 4 x 3.5" pull-out hard disk (without shock absorption) B: 2 x 3.5" pull-out hard disk (with shock absorption) Note: Server motherboard supports SAS hard disk installation, and all hard disks are arranged inside the safety door, which ensures data security
I/O Ports	Power switch, reset switch, power supply and hard disk indicators; 2 x USB2.0 port inside the safety door with a lock Ports at rear: depends on motherboard
Power Supply	Supports standard PS2 ATX power supply; supports 2U redundant power supply:500W(1+1), 700W(1+1), 1000W(1+1).
Working Temperature	ECO/EPE configuration: 0°C~50°C, 5%~90%(non-condensing) EATX server configuration: 0°C~40°C, 5%~90%(non-condensing)
Storage Temperature	-20°C~60C, 5%~90%(non-condensing)
Dimensions (W×H×D)	482 mm×177 mm×552 mm(excluding mounting ear)

Ordering Information

Part No.	Model	Description
0020-066191	IPC-860/SVE-2901VD-2N(B)-ES	C612 platform moterboard/supports dual-Xeon E5 V3/V4 CPU/16 x DDR4 DIMM/motherboard has no integrated RAID function/4 x 3.5" pull-out hard disk bay/1 x ultra-thin optical drive/800W+800W redundant power supply/2 x GbE/1 x COM/1 x VGA/6 x USB(2 x USB2.0 at front, 4 x USB3.0 at rear)/1 x full-height PCI-E X16, 1 x full-height PCIE X8(2x CPU: 2 x full-height PCIE X16, 4 x full-height PCIE X8)
0020-062571	IPC-860/ECO-1818-C236/350W	C236 platform moterboard/350W power supply/2 x Gigabit LAN port (I210) /2 x COM/any three display ports among onboard VGA, HDMI, DVI-D, DP/6 x USB(2 at front, 4 at rear)/1 group of audio ports/expansion: 2 x PCI+3 x PCIEX4 (X8 connector) +2 x PCIEX16 (see the manual for detailed resource)
0020-064991	IPC-860/ECO-1821/600W	C246 platform moterboard/600W power supply/2 x COM/2 x Gigabit LAN port/8 x USB (2 at front, 6 at rear) / any three display ports among four (VGA, DVI-D, DP, HDMI), 1 group of audio ports; expansion: 2 x PCI, 3 x PCIE x4, 2 x PCIE x16; 1 x M.2 KEY M port (PCIE X4, supporting sizes 2242/2260/2280/22110); 1 x M.2 KEY E port (PCIE X1, supports size 2230) Note: When two PCIE*16 slots are used at same time, the speed is reduced to the speed of PCIE*8
0020-066481	IPC-860/ECO-1823-03/600W	Q470E platform moterboard/600W power supply/1 x COM, 10 x USB (2 at front, 8 at rear) , 2 x Gigabit LAN port, VGA+DP+DVI-D, 1 group of audio ports, expansion: 2 x PCI, 2 x PCIE x16, 3 x PCIE x4 Note: When two PCIE X16 slots are used at same time, the speed is reduced to the speed of PCIE X8
0020-066491	IPC-860/ECO-1823-03/1000W	Q470E platform moterboard/1000W power supply/1 x COM, 10 x USB (2 at front, 8 at rear) , 2 x Gigabit LAN port, VGA+DP+DVI-D, 1 group of audio ports, expansion: 2 x PCI, 2 x PCIE x16, 3 x PCIE x4 Note: When two PCIE X16 slots are used at same time, the speed is reduced to the speed of PCIE X8
0020-066501	IPC-860/ECO-1823-04/1000W	W480E platform moterboard/1000W power supply/1 x COM, 10 x USB (2 at front, 8 at rear) , 2 x Gigabit LAN port, VGA+DP+DVI-D, 1 group of audio ports, expansion: 2 x PCI, 2 x PCIE x16, 3 x PCIE x4 Note: When two PCIE X16 slots are used at same time, the speed is reduced to the speed of PCIE X8

Note: The final interpretation rights for product specifications, ordering information, etc. belong to EVOC Intelligent Technology Co., Ltd.

MGP-800

Embedded GPU Computing Platform

MGP-800 is an embedded GPU computing platform composed of a fanless PC and a GPU expansion box. It features flexible expansion and supports two full-height full-length GPU cards. It adopts Intel W480E chipset, and supports 10/11th-generation Xeon Core processors. It supports expansion to multiple IO ports by means of high-speed connectors, and users can self-define the ports (for example, optional expansion to multiple POE network ports) to meet different application needs. It is mainly used in machine vision, deep learning, AI artificial intelligence and edge computing, vehicle-road coordination, assisted driving and other application fields.



MGP-800-01



MGP-800-02

Product Features



Strong AI computing power



Supports 4G, WIFI communication



Professional power supply solution

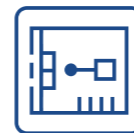

Super EMC performance

Product Dimensions Drawing

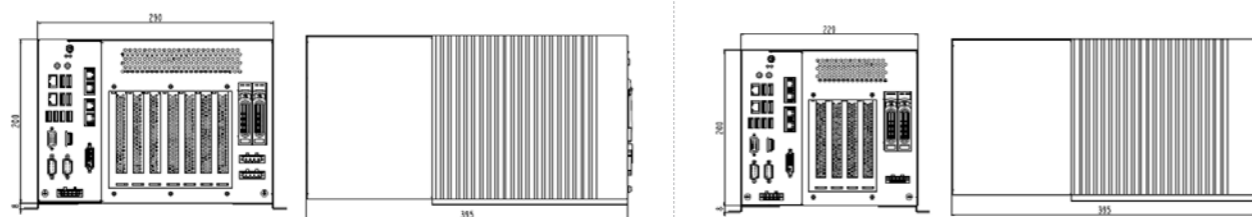

Please refer to the user manual to check detailed specifications and dimension. (Unit: MM)

Product Specifications

Item	Description						
System Configuration	Processor	Supports Intel 10/11th-generation Xeon Core series processors whose power consumption is no more than 80W					
	Chipset	W480E					
	Memory	2 x 260-Pin DDR4 SO-DIMM, supporting up to 64G					
I/O Ports	External Ports	2 x RJ45 4 x USB3.2(GEN2), 4 x USB3.2(GEN1) 2 x COM port, RS-232/422/485 adjustable, 4 x built-in RS-232 (optional) 1 group of audio ports (1 x line out, 1 x mic in) VGA, HDMI (built-in optional expansion to 1 x DVI port)					
	Internal Ports	1 x 8-channel GPIO 1 x USB2.0 (1 x 5 Pin wafer socket, built-in watchdog expandable via USB cable) 4 SATA3.0 (6Gbps), supporting RAID 0/1/5/10 1 x TPM port, supporting TPM2.0					
Expansion Bus		1 x MiniPCIE port (SATA signal), expandable to either 4G module or MSATA storage 1 x SIM card slot 1 x M.2 Key E (expansion to WIFI module) 1 x 2 x 30Pin high speed connector, self-defined expansion port					
CPU Card		MGP-800-01: 2 x PCIe x 16 (PCIe x 8 signal), 2 x PCIe x 4 MGP-800-02: 1 x PCIe x 16, 2 x PCIe x 4 Length of expansion card ≤ 331mm Supports mainstream GPU expansion cards on the market, up to three fans GPU card In case of single GPU card expansion, the thickness of the expansion card ≤ 62.96mm In case of dual GPU card expansion, the recommended gap between the two expansion cards ≥ 5mm					
Storage		Supports up to 4 x 2.5" SATA 3.0 hard disk Among them: 1 x 2.5" hard disk bay inside the fanless PC; The expansion box supports 2 x 2.5" hard disk pull-out bay (supporting hotswap) The expansion box supports internal 1 x 2.5" hard disk bay (optional) Supports 1 x M-SATA slot (realizing 4G, or storage function; the 4G function and the storage expansion cannot co-exist for use)					
Remote Maintenance		Supports AMT function					
Power Supply		External AC 220V power adapter for power supply; 480W or 1000W power supply optional					
Switch/Indicator		1 x power switch, 1 x phoenix terminal; Indicator: power supply and hard disk indicators					
Environmen Requirements	Working Temperature		HDD&normal temperature SSD Excluding GPU card	Wide-temperature SSD Excluding GPU card	Wide-temperature SSD 1 x 250W power consumption GPU	Wide-temperature SSD 1 x 350W power consumption GPU	Wide-temperature SSD 2 x 250W power consumption GPU
		35W	0°C~45°C	-20°C~60°C	-20°C~60°C	-20°C~60°C	-20°C~60°C
65W		-20°C~50°C		-20°C~50°C	-20°C~40°C	-20°C~40°C	
80W	-20°C~45°C	-20°C~40°C		-20°C~40°C	-20°C~40°C		
	Storage Temperature	-40°C~85°C; 95%@40°C(non-condensing)					
Dimensions (W x H x D)		Dimensions of dual GPU expansion complete PC: 290mm(W) x 200mm(H) x 395mm(D) Dimensions of single GPU expansion complete PC: 229mm(W) x 200mm(H) x 395mm(D)					
Operating System		WIN10, Server 2019, Cent OS, Linux, Ubuntu and other high kernel version LINUX systems.					

Ordering Information

Part No.	Model	Description
0020-066171	MGP-800-01 barebone system	Embedded GPU computing platform/Intel®W480E chipset/2 x Gigabit LAN port/VGA+HDMI/4 x USB3.2(GEN2), 4 x USB3.2(GEN1) /2 x COM, supporting RS-232/422/485 adjustable/1 group of audio ports/2 x PCIe X16 (PCIe x 8 signal) /2 x PCIe X4
0020-066181	MGP-800-02 barebone system	Embedded GPU computing platform/Intel®W480E chipset/2 x Gigabit LAN port/VGA+HDMI/4 x USB3.2(GEN2), 4 x USB3.2(GEN1)/2 x COM, supporting RS-232/422/485 adjustable/1 group of audio ports/1 x PCIe X16/2 x PCIe X4
0010-161251	MGP-800-01	Embedded GPU computing platform/Intel®W480E chipset/i9-11900 eight-core processor/2 x 16G memory/256GSSD/2 x Gigabit LAN port/VGA+HDMI/4 x USB3.2(GEN2), 4 x USB3.2(GEN1)/2 x DB9, supporting RS-232/422/485 adjustable/1 group of audio ports/2 x PCIe X16 (PCIe x 8 signal) /2 x PCIe X4
0010-161261	MGP-800-02	Embedded GPU computing platform/Intel®W480E chipset/i7-11700 eight-core processor/2 x 16G memory/256GSSD/2 x Gigabit LAN port/VGA+HDMI/4 x USB3.2(GEN2), 4 x USB3.2(GEN1)/2 x COM, supporting RS-232/422/485 adjustable/1 group of audio ports/1 x PCIe X16/2 x PCIe X4

Optional Accessories

Part No.	Model	Description
1060-010141	EF-4LAN-004POE	High speed connector expansion card, Intel I225LM chip, 4 x POE Gigabit LAN port card
1060-010851	EF-4LAN-004	High speed connector expansion card, Intel I225LM chip, 4 x Gigabit LAN port card
1060-010861	EF-4LAN-004-2LAN	High speed connector expansion card, Intel I225LM chip, 2 x Gigabit LAN port card
1060-010131	EF-HDD-025ECS	High speed connector expansion card, 1 x M.2 KEY M port, supporting PCIe SSD
1500-008561	1000W power supply assembly optional package	1000W power supply assembly/one end connected to national standard AC power supply cord/the other end connected to 3 groups of power cord to filter board assembly with phoenix terminal
1500-008581	480W power supply assembly optional package	480W power supply assembly/one end connected to two groups of power supply cord with phoenix terminal/the other end connected to national standard AC power supply cord

Note: The final interpretation rights for product specifications, ordering information, etc. belong to EVOC Intelligent Technology Co., Ltd.

EC0-1816 (F)

Embedded GPU Computing Platform

EC0-1816 is an ATX structure motherboard developed based on Intel H61 chipset. It supports Ivy bridge/Sandy bridge LGA1155 pin processors, VGA+DVI-D display function, multiple IO ports, and PCIe, PCI bus expansion. It can be widely used in industrial automation control, automatic testing, safety monitoring, intelligent transportation, communication automation, environmental protection testing, and other fields.



Product Features



1 x M.2 port



10 x USB port

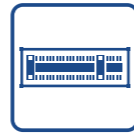

4 x PCI+2 x PCIe expansion

Product Dimensions Drawing

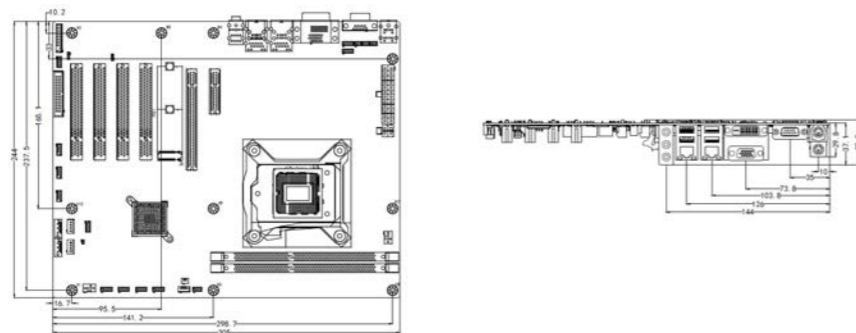

Please refer to the user manual to check detailed specifications and dimension. (Unit: MM)

Product Specifications

Item	Description
Processor	Supports Ivy bridge/Sandy bridge LGA 1155 pin processors
Chipset	H61
Memory	2 x 240Pin standard DDR3 DIMM memory slot, a single memory supporting 8GB, the two supporting up to 16GB
Display Ports	1 x VGA 1 x DVI-D
Audio Ports	Supports MIC-IN/LINE-IN/LINE-OUT
LAN	2 x Gigabit LAN port LAN1 supporting Wake-on-LAN Note: Because PCIe x4 slot and LAN2 share resource, when PCIe x4 is occupied, LAN2 network port can not work.
Storage	3 x SATA2.0, supporting hotswap function under AHCI mode
IO Ports	1 x parallel port 6 x COM port, including COM1 onboard, supporting RS-232/422/RS-485 mode selection 1 x M.2 KEY-B-2280 port 10 x USB2.0 port 1 x PS/2 port 1 x 8-channel digital I/O port 1 x TPM port
Bus Expansion	4 x PCI 1 x PCIe x16 1 x PCIe x4 (actually providing x1 signal)
Power Supply	ATX power supply
Working Environment	-10°C~60°C
Storage Environment	-20°C~80°C
Relative Humidity	5%~95% (non-condensing)
Dimensions	305mm (L) × 244mm (W) × 39.9mm (H)
Operating System	WINXP, WINXPE, WIN7, LINUX systems

Ordering Information

Part No.	Model	Description
0030-023521 1030-030801	EC0-1816(F)	ATX structure motherboard/H61 chipset/supports Ivy Bridge Sandy Bridge LGA1155 pin processors/2 x DDR3 memory slot/VGA+DVI-D/2 x Gigabit LAN port/3 x SATA2.0/1 x M.2 KEY-B-2280 port/10 x USB2.0/6 x COM port/4 x PCI/1 x PCI_Ex16/1 x PCIe x4/1 x LPT/1 x 8-channel GPIO/1 x TPM/1 group of audio ports
0030-023531 1030-032341	EC0-1816(F)-NS	ATX structure motherboard/H61 chipset/supports Ivy Bridge Sandy Bridge LGA1155 pin processors/2 x DDR3 memory slot/VGA+DVI-D/2 x Gigabit LAN port/3 x SATA2.0/1 x M.2 KEY-B-2280 port/10 x USB2.0/6 x COM port/4 x PCI/1 x PCI_Ex16/1 x PCIe x4/1 x LPT/1 x 8-channel GPIO/1 x TPM/no sound card

Note: The final interpretation rights for product specifications, ordering information, etc. belong to EVOC Intelligent Technology Co., Ltd.

EC0-1816(E)

ATX Structure Motherboard

EC0-1816(E) is an ATX structure motherboard developed based on Intel H61 chipset. It supports Ivy Bridge/Sandy bridge core LGA1155 pin dual-core/quad-core processors, VGA+DVI-D display function, and PCIe/PCI bus expansion. It can be widely used in industrial automation control, automatic testing, safety monitoring, intelligent transportation, communication automation, environmental protection testing and other fields.

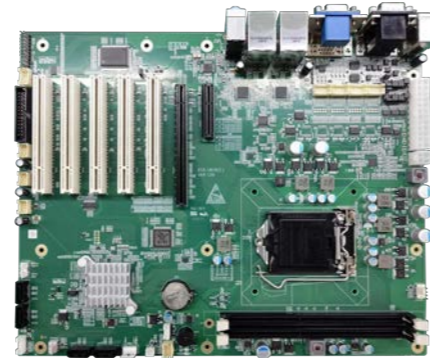

Product Features



10 x COM port



10 x USB port

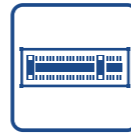

5 x PCI+2 x PCIe expansion

Product Dimensions Drawing

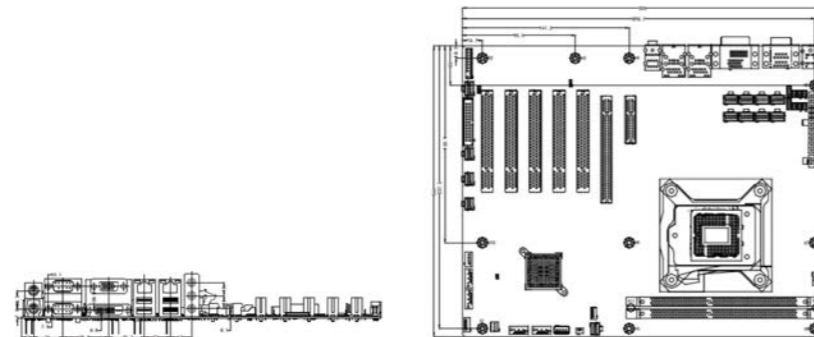

Please refer to the user manual to check detailed specifications and dimension. (Unit: MM)

Product Specifications

Item	Description
Processor	Supports Ivy bridge/Sandy bridge LGA 1155 pin processors
Chipset	H61
Memory	2 x 240Pin standard DDR3 DIMM memory slot, a single memory supporting 8GB, the two supporting up to 16GB
Display Ports	1 x VGA, 1 x DVI-D
Audio Ports	Supports MIC-IN/LINE-IN/LINE-OUT
LAN	2 x Gigabit LAN port, LAN1 supporting Wake-on-LAN
Storage	4 x SATA2.0
IO Ports	1 x parallel port 6 x COM port, COM1, COM2 onboard, supporting RS-232/422/RS-485 mode selection, (optional motherboard with 10 COM ports) 10 x USB2.0 port 1 x PS/2 port 1 x 8-channel digital I/O port 1 x TPM port
Bus Expansion	5 x PCI 1 x PCIe16 1 x PCIe4 (actually providing x1 signal)
Power Supply	ATX power supply
Working Environment	-10°C~60°C
Storage Environment	-20°C~80°C
Relative Humidity	5%~95% (non-condensing)
Dimensions	305mm (L)×244mm (W)
Operating System	WINXP, WINXPE, WIN7, LINUX systems

Ordering Information

Part No.	Model	Description
1030-030621	EC0-1816(E)-6COM-01	ATX structure motherboard/Intel H61 chipset/supports Intel Sandy bridge/Ivy bridge LGA1155 processors/2 x DDR3 DIMM memory slot, supporting up to 16GB memory/VGA+DV-D/4 x SATA/2 x Gigabit LAN port/10 x USB2.0/6 x COM port (among them, two support 232/422/485)/1 x parallel port/1 x PS/2/1 group of Audio ports/1 x 8-channel GPIO/5 x PCI/1 x PCIe1/1 x PCIe16/1 x TPM port/standard ATX power supply
1030-030641	EC0-1816(E)-10COM-01	ATX structure motherboard/Intel H61 chipset/supports Intel Sandy bridge/Ivy bridge LGA1155 processors/2 x DDR3 DIMM memory slot, supporting up to 16GB memory/VGA+DV-D/4 x SATA/2 x Gigabit LAN port/10 x USB2.0/10 x COM port (among them, two support 232/422/485)/1 x parallel/1 x PS/2/1 group of Audio ports/1 x 8-channel GPIO/5 x PCI/1 x PCIe1/1 x PCIe16/1 x TPM port/standard ATX power supply

Note: The final interpretation rights for product specifications, ordering information, etc. belong to EVOC Intelligent Technology Co., Ltd.

EC0-1817 (B)

ATX Structure Motherboard

EC0-1817 (B) is an ATX structure motherboard developed based on Intel H81 chipset. It supports 4th Gen processor packaged in Intel Socket LGA1150, VGA+DVI-D dual display function, multiple IO ports, and PCIe/PCI bus expansion. It can be widely used in petrochemical industry, automation control, automatic testing, safety monitoring, intelligent transportation, communication automation, environmental protection testing, and other fields.

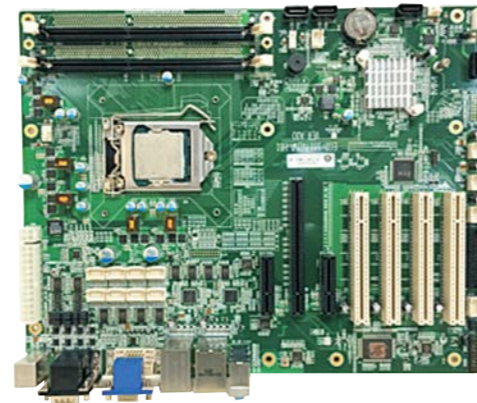

Product Features



10 x COM port



10 x USB port

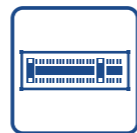

4 x PCI+3 x PCIe expansion

Product Dimensions Drawing

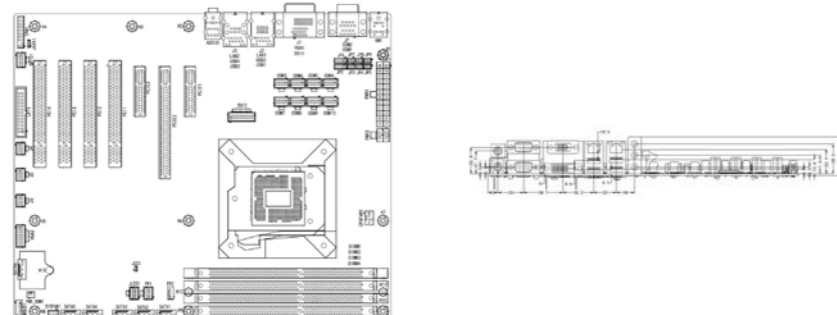

Please refer to the user manual to check detailed specifications and dimension. (Unit: MM)

Product Specifications

Item	Description
Processor	Supports Intel Haswell LGA 1150 pin 4th Gen processors
Chipset	H81
Memory	2 x 240Pin standard DDR3 DIMM memory slot, a single memory supporting 8GB, the two supporting up to 16GB
Display Ports	1 x VGA, 1 x DVI-D
Audio Ports	Supports MIC-IN/LINE-IN/LINE-OUT
LAN	2 x Gigabit LAN port, LAN1 supporting Wake-on-LAN
Storage	4 x SATA2.0
IO Ports	1 x parallel port 10 x COM port, COM1, COM2 support RS-232/RS-422/RS-485 mode selection 2 x USB 3.0, 8 x USB 2.0 1 x PS/2 port 1 x 8-channel digital I/O port 1 x TPM port
Bus Expansion	4 x PCI 1 x PCIe16 2 x PCIe4 (actually providing x1 signal)
Power Supply	ATX power supply
Working Environment	-10°C~60°C
Storage Environment	-20°C~80°C
Relative Humidity	5%~95% (non-condensing)
Dimensions	305mm (L) x 244mm (W)
Operating System	WINXP, WIN7, LINUX systems

Ordering Information

Part No.	Model	Description
1030-030741	EC0-1817V2NA(B)-H81-6COM	ATX structure motherboard/supports Intel Haswell LGA 1150 pin 4th-generation processors/H81 chipset/2 x DDR3 memory slot/VGA+DVI-D/2 x Gigabit LAN port/4 x SATA2.0/10 x USB/6 x COM port/4 x PCI/1 x PCIe16/2 x PCIe4 (actually providing X1 signal) /1 x parallel port/1 x 8-channel GPIO/1 x TPM/1 group of audio ports
1030-032361	EC0-1817V2NA(B)-H81-6COM-NS	ATX structure motherboard/supports Intel Haswell LGA 1150 pin 4th-generation processors/H81 chipset/2 x DDR3 memory slot/VGA+DVI-D/2 x Gigabit LAN port/4 x SATA2.0/10 x USB/6 x COM port/4 x PCI/1 x PCIe16/2 x PCIe4 (actually providing X1 signal) /1 x parallel port/1 x 8-channel GPIO/1 x TPM/no audio
1030-032371	EC0-1817V2NA(B)-H81	ATX structure motherboard/supports Intel Haswell LGA 1150 pin 4th-generation processors/H81 chipset/2 x DDR3 memory slot/VGA+DVI-D/2 x Gigabit LAN port/4 x SATA2.0/10 x USB/10 x COM port/4 x PCI/1 x PCIe16/2 x PCIe4 (actually providing X1 signal) /1 x parallel port/1 x 8-channel GPIO/1 x TPM/1 group of audio ports

Note: The final interpretation rights for product specifications, ordering information, etc. belong to EVOC Intelligent Technology Co., Ltd.

EC0-1818 (C)

ATX Structure Motherboard

EC0-1818 (C) motherboard is equipped with Intel's H110 platform, supports the 6/7th Gen processors, adopts standard ATX motherboard specifications, and has the characteristics of optimal cost-effectiveness and long lifetime. The motherboard supports 4 x PCI+2 x PCIE expansion combination, 6 x COM ports, 10 x USB, supports any two display ports among VGA, HDMI, and DVI-D. As the company's main product for the next 5-7 years, this product will be widely used in petrochemical industry, automation control, automatic testing, and safety monitoring, Intelligent transportation, environmental protection, communication and other fields.



Product Features



Supports Intel 6/7th-generation processors



10 x USB port

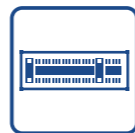

4 x PCI+
3 x PCIE expansion

Product Dimensions Drawing

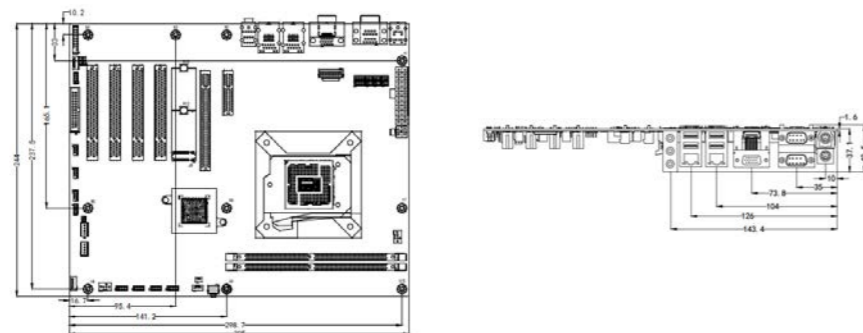

Please refer to the user manual to check detailed specifications and dimension. (Unit: MM)

Product Specifications

Item	Description
Processor	Supports Intel LGA 1151 pin 6/7th Gen processors
Chipset	H110
Memory	2 x DDR4 DIMM memory slot, a single memory supporting 16GB, the two supporting up to 32GB
Display Ports	Any two display ports among VGA, HDMI, DVI-D Among them, VGA+HDMI ports are onboard, and DVI-D uses WAFER socket
Audio Ports	Supports MIC-IN/LINE-IN/LINE-OUT
LAN	2 x Gigabit LAN port, LAN1 supporting Wake-on-LAN
Storage	3 x SATA3.0, 1 x M.2
IO Ports	1 x parallel port 6 x COM port, COM1, COM2 support RS-232/RS-422/RS-485 mode selection 4 x USB 3.0, 6 x USB 2.0 1 x PS/2 port 1 x 8-channel digital I/O port 1 x TPM port
Bus Expansion	4 x PCI 1 x PCIEx16 1 x PCIEx4
Power Supply	ATX power supply
Working Environment	-10°C~60°C
Storage Environment	-20°C~80°C
Relative Humidity	5%~95% (non-condensing)
Dimensions	305mm (L) x 244mm (W)
Operating System	WIN7, WIN10, LINUX systems

Ordering Information

Part No.	Model	Description
0030-022801	EC0-1818(C)	ATX structure motherboard/H110 chipset/supports Intel LGA1151 pin 6/7th Gen processors/2 x DDR4 DIMM memory slot, supporting up to 32GB memory/VGA+HDMI onboard, 1 x DVI-D pin/3 x SATA3.0+1 x M.2/2 x Gigabit LAN port/4 x USB3.0, 6 x USB2.0/6 x COM port/1 x parallel port/1 x PS/2/1 group of audio ports/1 x 8-channel GPIO/4 x PCI/1 x PCIE x4/1 x PCIE x16/1 x TPM/standard ATX power supply

Note: The final interpretation rights for product specifications, ordering information, etc. belong to EVOC Intelligent Technology Co., Ltd.

EC0-1818-C236

ATX Structure Motherboard

EC0-1818-C236 motherboard adopts standard ATX motherboard specifications and C236 chipset, supports PCI+PCIE expansion combination, multiple COM ports, and multiple USB ports, and has the characteristics of long lifetime and high performance. This product will be widely used in petrochemical industry, automation control, automatic testing, safety monitoring, intelligent transportation, environmental protection, communication and other fields.



Product Features



Supports Intel 6/7th Gen processors



Supports 4 x memory slot



14 x USB port



2 x PCI+ 5 x PCIE expansion

Product Dimensions Drawing

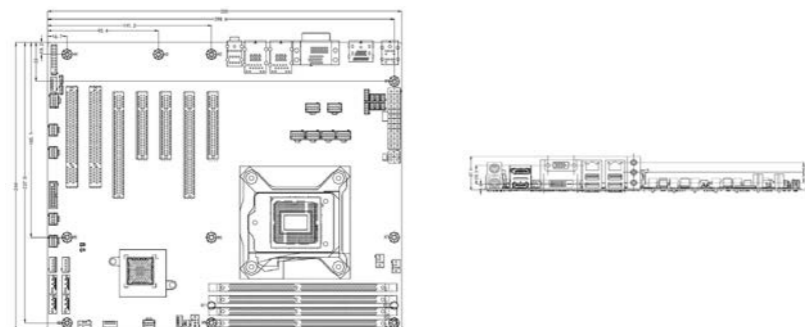

Please refer to the user manual to check detailed specifications and dimension. (Unit: MM)

Product Specifications

Item	Description
Processor	Supports Intel LGA 1151 pin 6/7th Gen processors, and Xeon E3-1200 V5/V6 series processors
Chipset	C236
Memory	4 x DDR4 DIMM memory slot, a single memory module supporting 16GB, the four supporting up to 64GB, support ECC RAM
Display Ports	Any three display ports among VGA, HDMI, DVI-D, DP
Audio Ports	Supports MIC-IN/LINE-IN/LINE-OUT
LAN	2 x Gigabit LAN port, LAN1 supporting Wake-on-LAN
Storage	4 x SATA3.0
IO Ports	6 x COM port, COM1, COM2 supporting RS-232/RS-422/RS-485 mode selection 6 x USB 3.0, 8 x USB 2.0 1 x PS/2 port 1 x 8-channel digital I/O port 1 x TPM port
Bus Expansion	2 x PCI 2 x PCIe16 (when PCIe5 slot is occupied, the two PCIe slot use the speed of PCIe8 by default) 3 x PCIe4 (using x8 connector)
Power Supply	ATX power supply
Working Environment	-10°C~60°C
Storage Environment	-20°C~80°C
Relative Humidity	40°C 95%RH, non-condensing
Dimensions	305mm (L)×244mm (W)
Operating System	WIN7, WIN10, Linux, Server2008, Server2010 Note: LAN port chip is a motherboard of I211, and Server operating system is not supported

Ordering Information

Part No.	Model	Description
0030-023891	EC0-1818-C236-I211-01	ATX structure motherboard/C236 chipset/supports Intel6/7th Gen LGA 1151 pin processors/4 x 288Pin DDR4 DIMM memory slot, supporting up to 64GB memory/any three display ports among DP, HDMI, VGA, DVI-D/4 x SATA3.0/2 x Gigabit LAN port(I211 chip)/14 x USB/6 x RS-232/1 group of audio ports/1 x 8-channel GPIO/2 x PCIe x16/3 x PCIe4(X8 connector)/2 x PCI
0030-023911	EC0-1818-C236-I210-01	ATX structure motherboard/C236 chipset/supports Intel 6/7th Gen LGA 1151 pin processor/4 x 288Pin DDR4 DIMM memory slot, supporting up to 64GB memory/any three display ports among DP, HDMI, VGA, DVI-D/4 x SATA3.0 /2 x Gigabit LAN port(I210 chip)/14 x USB/6 x RS-232/1 group of audio ports/1 x 8-channel GPIO/2 x PCIe x16/3 x PCIe4(X8 connector)/2 x PCI

Note: The final interpretation rights for product specifications, ordering information, etc. belong to EVOC Intelligent Technology Co., Ltd.

EC0-1820

ATX Structure Motherboard

EC0-1820 motherboard adopts standard ATX specifications and Intel H310 chipset, and supports latest Intel 8/9th Gen processors. It supports PCI+PCIE expansion combination, multiple COM ports, and multiple USB ports. The product can be widely used in petrochemical industry, automation control, automatic testing, safety monitoring, intelligent transportation, environmental protection, communication and other fields.



Product Features



Supports Intel 8/9th Gen processors



10 x USB port

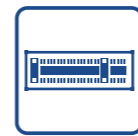

4 x PCI+
3 x PCIe expansion

Product Dimensions Drawing

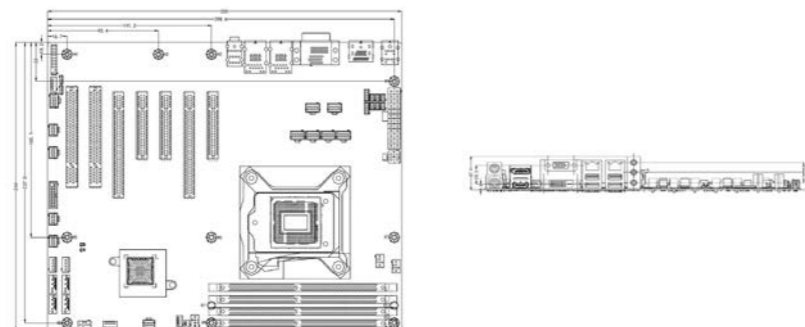

Please refer to the user manual to check detailed specifications and dimension. (Unit: MM)

Product Specifications

Item	Description
Processor	Supports Intel LGA 1151 pin 8/9th Gen processors
Chipset	H310
Memory	2 x DDR4 DIMM memory slot, a single memory module supporting 16GB, the two supporting up to 32GB
Display Ports	Any two display ports among VGA, HDMI, DVI-D, DP
Audio Ports	Supports MIC-IN/LINE-IN/LINE-OUT
LAN	2 x Gigabit LAN port, LAN1 supporting Wake-on-LAN
Storage	4 x SATA3.0
IO Ports	10 x COM port, COM1, COM2 supporting RS-232/RS-422/RS-485 mode selection 4 x USB 3.0, 6 x USB 2.0 1 x PS/2 port 1 x 8-channel digital I/O port 1 x TPM port
Bus Expansion	5 x PCI 1 x PCIe16 1 x PCIe4
Power Supply	ATX power supply
Working Environment	-10°C~60°C
Storage Environment	-20°C~80°C
Constant Damp Heat	40°C 95%RH, non-condensing
Dimensions	305mm (L)×244mm (W)
Operating System	WIN10, Linux

Ordering Information

Part No.	Model	Description
0030-022941	EC0-1820(B)	ATX structure motherboard/H310 chipset/supports Intel8/9th Gen processors/2 x DDR4 DIMM memory slot/any three display ports among VGA, HDMI, DVI-D, DP/4 x SATA3.0/2 x Gigabit LAN port/10 x USB/10 x RS-232/1 group of audio ports/1 x 8-channel GPIO/expansion: 5 x PCI, 1 x PCIe4, 1 x PCIe16
0020-064471	IPC-810/EC0-1820(B)/250W	H310 platform motherboard/250W power supply/2 x COM/6 x USB (2 at front, 4 at rear)/2 x Gigabit LAN port/any two display ports among VGA, HDMI, DVI-D, DP/1 group of audio ports/1 x PS2/expansion: 5 x PCI, 1 x PCIe4, 1 x PCIe16
0020-065321	IPC-810/EC0-1820(B)-NS/250W	H310 platform motherboard/250W power supply/2 x COM/6 x USB (2 at front, 4 at rear)/2 x Gigabit LAN port/any two display ports among VGA, HDMI, DVI-D, DP/no sound card/1 x PS2/expansion: 5 x PCI, 1 x PCIe4, 1 x PCIe16
0010-140681	IPC-810E/EC0-1820(B)/G4900/4G/1TB/250W	H310 platform motherboard/G4900/4G memory/1T hard disk/250W power supply/6 x COM/6 x USB (2 at front, 4 at rear)/2 x Gigabit LAN port/any two display ports among VGA, HDMI, DVI-D, DP/1 group of audio ports/1 x PS2/expansion: 5 x PCI, 1 x PCIe4, 1 x PCIe16
0010-140691	IPC-820/EC0-1820(B)/I7-9700/4G/1TB/300W	H310 platform motherboard/I7-9700/4G memory/1T hard disk/300W power supply/6 x COM/6 x USB (2 at front, 4 at rear)/2 x Gigabit LAN port/any two display ports among VGA, HDMI, DVI-D, DP/1 group of audio ports/1 x PS2/1 x LPT/expansion: 5 x PCI, 1 x PCIe4, 1 x PCIe16

Note: The final interpretation rights for product specifications, ordering information, etc. belong to EVOC Intelligent Technology Co., Ltd.

EC0-1821

ATX Structure Motherboard

EC0-1821 motherboard adopts standard ATX specifications and Intel C246 platform, and supports Intel 8/9th Gen processors. It supports PCI+PCIE expansion combination, multiple COM ports, multiple USB ports, and SATA RAID 0, 1, 5, 10. The product can be widely used in industrial automation, IOT, self-service terminals, petrochemical industry, safety monitoring, intelligent transportation, environmental protection, communication and other fields.



Product Features

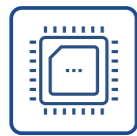

supports Intel 8/9th Gen processors



Supports 4 x memory slot



12 x USB port

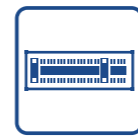

2 x PCI+ 5 x PCIE expansion

Product Dimensions Drawing

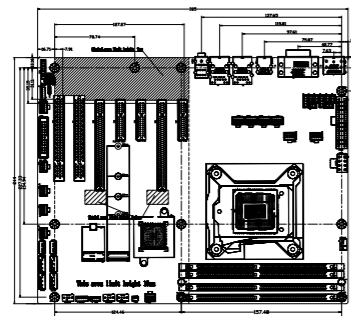

Please refer to the user manual to check detailed specifications and dimension. (Unit: MM)

Product Specifications

Item	Description
Processor	Supports Intel LGA 1151 pin: 8/9th Gen processors, Xeon E-21xx/E-22xx series processors
Chipset	C246
Memory	4 x DDR4 DIMM memory slot, a single memory supporting 32GB, the four supporting up to 128GB
Display Ports	Any three display ports among VGA, HDMI, DVI-D and DP
Audio Ports	Supports MIC-IN/LINE-IN/LINE-OUT
LAN	2 x Gigabit LAN port, LAN1 supporting Wake-on-LAN
Storage	4 x SATA3.0, supporting RAID 0, 1, 5, 10
IO Ports	6 x COM port, COM1, COM2 support RS-232/RS-422/RS-485 mode selection 6 x USB 2.0 port, 4 x USB3.1 GEN2 port (10Gb/s), 2 x USB3.1 GEN1 port (5Gb/s) 1 x PS/2 port 1 x 8-channel digital I/O port 1 x TPM port
Bus Expansion	2 x PCI, 3 x PCIe4 2 x PCIe16 (when PCIe5 slot is occupied, the two PCIe slots adopts PCIe8 speed by default) 1 x M.2 KEY M port (PCIe X4, supporting sizes 2242/2260/2280/22110) 1 x M.2 KEY E port (PCIe X1, supporting size 2230)
Power Supply	ATX power supply
Working Environment	-10°C~60°C
Storage Environment	-20°C~80°C
Constant Damp Heat	40°C 95%RH, non-condensing
Dimensions	305mm (L) × 244mm (W)
Operating System	WIN10, Linux

Ordering Information

Part No.	Model	Description
0030-023201	EC0-1821	ATX structure motherboard/C246 chipset/supports Intel 8/9th Gen processors/provides 4 x DDR4 DIMM, expandable up to 128 GB/any three display ports among DP, HDMI, VGA, DVI-D/4 x SATA3.0, supporting RAID 0, 1, 5, 10/2 x Gigabit LAN port/12 x USB/6 x COM port/1 group of audio ports/1 x 8-channel GPIO/1 x TPM port/1 x PS2 pin on motherboard/expansion ports: 2 x PCI, 3 x PCIe x4, 2 x PCIe x16/1 x M.2 KEY M port (PCIe X4, supporting sizes 2242/2260/2280/22110), 1 x M.2 KEY E port (PCIe X1, supporting size 2230) Note: When the two PCIe x16 slots are occupied at same time, the speed will be reduced to the speed of PCIe x8
0030-023211	EC0-1821-I210	ATX structure motherboard/C246 chipset/supports Intel 8/9th Gen processors/provides 4 x DDR4 DIMM, expandable up to 128 GB/any three display ports among DP, HDMI, VGA, DVI-D/4 x SATA3.0, supporting RAID 0, 1, 5, 10/2 x Gigabit LAN port/12 x USB/6 x COM port/1 group of audio ports/1 x 8-channel GPIO/1 x TPM port/1 x PS2 pin on motherboard/expansion port: 2 x PCI, 3 x PCIe x4, 2 x PCIe x16/1 x M.2 KEY M port (PCIe X4, supporting sizes 2242/2260/2280/22110), 1 x M.2 KEY E port (PCIe X1, supporting size 2230) Note: When the two PCIe x16 slots are occupied at same time, the speed will be reduced to the speed of PCIe x8
0020-064981	IPC-810/EC0-1821/300W	C246 platform motherboard/300W power supply/2 x COM/2 x Gigabit LAN port/8 x USB (2 at front, 6 at rear) /any three display ports among VGA, DVI-D, DP, HDMI/1 group of audio ports/expansion: 2 x PCI, 3 x PCIe x4, 2 x PCIe x16/1 x M.2 KEY M port(PCIe X4, supporting sizes 2242/2260/2280/22110); 1 x M.2 KEY E port (PCIe X1, supporting size 2230) Note: When the two PCIe x16 slots are occupied at same time, the speed will be reduced to the speed of PCIe x8
0020-065481	IPC-810/EC0-1821-NS/300W	C246 platform motherboard/300W power supply/2 x COM/2 x Gigabit LAN port/8 x USB (2 at front, 6 at rear) /any three display ports among VGA, DVI-D, DP, HDMI/no sound card/ expansion: 2 x PCI, 3 x PCIe x4, 2 x PCIe x16/1 x M.2 KEY M port(PCIe X4, supporting sizes 2242/2260/2280/22110); 1 x M.2 KEY E port (PCIe X1, supporting size 2230) Note: When the two PCIe x16 slots are occupied at same time, the speed will be reduced to the speed of PCIe x8
0020-064991	IPC-860/EC0-1821/600W	C246 platform motherboard/600W power supply/2 x COM/2 x Gigabit LAN port/8 x USB (2 at front, 6 at rear) /any three display ports among VGA, DVI-D, DP, HDMI/1 group of audio ports/expansion: 2 x PCI, 3 x PCIe x4, 2 x PCIe x16/1 x M.2 KEY M port (PCIe X4, supporting sizes 2242/2260/2280/22110); 1 x M.2 KEY E port (PCIe X1, supporting size 2230) Note: When the two PCIe x16 slots are occupied at same time, the speed will be reduced to the speed of PCIe x8
0010-151371	IPC-810E/EC0-1821/I7-8700/8G/1T/300W	C246 platform motherboard/i7-8700/8G memory/1T HDD/300W power supply/6 x COM/2 x Gigabit LAN port/8 x USB (2 at front, 6 at rear) /any three display ports among VGA, DVI-D, DP, HDMI, 1 group of audio ports; expansion: 2 x PCI, 3 x PCIe x4, 2 x PCIe x16; 1 x M.2 KEY M port (PCIe X4, supporting sizes 2242/2260/2280/22110); 1 x M.2 KEY E port (PCIe X1, supporting size 2230) Note: When the two PCIe x16 slots are occupied at same time, the speed will be reduced to the speed of PCIe x8

Note: The final interpretation rights for product specifications, ordering information, etc. belong to EVOC Intelligent Technology Co., Ltd.

EC0-1822

ATX Structure Motherboard

EC0-1822 motherboard adopts standard ATX specifications and Intel H420E platform, and supports LGA 1200 pin 10th Gen processors. It provides 2 DDR4 DIMM memory slots, and supports PCI+PCIe expansion combination, multiple COM ports, and multiple USB ports. It can be widely used in industrial automation, IOT, self-service terminals, petrochemical industry, safety monitoring, intelligent transportation, environmental protection, communication and other fields.



Product Features

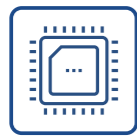

Supports Intel 10th Gen processors



Supports 2 x memory slot



10 x USB port

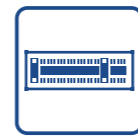

4 x PCI+
3 x PCIe expansion

Product Dimensions Drawing

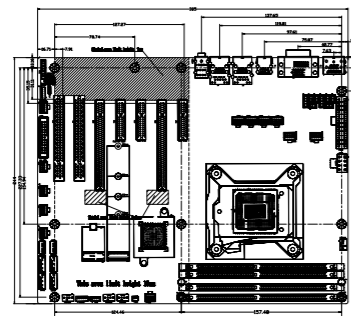

Please refer to the user manual to check detailed specifications and dimension. (Unit: MM)

Product Specifications

Item	Description
Processor	Supports Intel LGA 1200 pin 10th Gen processors, maximum power consumption of processor TDP≤125W
Chipset	H420E
Memory	2 x DDR4 DIMM memory slot, a single memory module supporting 32GB, the two supporting up to 64GB
Display Ports	Any three display ports among VGA, HDMI, DVI-D and DP
Audio Ports	Supports MIC-IN/LINE-IN/LINE-OUT
LAN	2 x Gigabit LAN port, LAN1 supporting Wake-on-LAN
Storage	4 x SATA3.0
IO Ports	6 x COM port, COM1, COM2 supporting RS-232/RS-422/RS-485 mode selection 4 x USB 2.0 port, 6 x USB3.2 GEN1 port 1 x PS/2 port 1 x 8-channel digital I/O port 1 x TPM port
Bus Expansion	4 x PCI 2 x PCIe4 (actually providing x1 signal) 1 x PCIe16 1 x M.2 KEY M port(PCIe x2, sizes 2242/2280)
Power Supply	ATX power supply
Working Environment	-10°C~60°C
Storage Environment	-20°C~80°C
Constant Damp Heat	40°C 95%RH, non-condensing
Dimensions	305mm (L)×244mm (W)
Operating System	WIN10, Linux

Ordering Information

Part No.	Model	Description
0030-023461	EC0-1822	ATX structure motherboard/H420E chipset/10th Gen LGA1200 pin processor/2 x DDR4 DIMM memory slot, supporting expansion up to 64 GB/any two display ports among VGA, DP and DVI-D/4 x SATA3.0, 1 x M.2 (PCIe3.0 x2 M-key 2280 type)/2 x Gigabit LAN port/6 x USB 3.2 Gen 1, 4 x USB 2.0/ 6 x COM/1 group of audio ports port/1 x 8 bit GPIO/1 x TPM/1 x LPT/1 x LPC/1 x PS2 on motherboard/expansion: 4 x PCI, 1 x PCIe x16, 2 x PCIe4 (actually providing the speed of x1)
0020-066411	IPC-710/EC0-1822/350W	H420E platform motherboard/350W power supply/2 x COM, 8 x USB (2 at front, 6 at rear)/2 x Gigabit LAN port/VGA+DP/1 group of audio ports/expansion: 4 x PCI, 2 x PCIe4 (actually providing the speed of x1), 1 x PCIe16
0020-065581	IPC-810/EC0-1822/300W/barebone system	H420E platform motherboard/300W power supply/2 x COM/8 x USB (2 at front, 6 at rear)/2 x Gigabit LAN port/VGA+DP/1 group of audio ports/expansion: 4 x PCI, 2 x PCIe4 (actually providing the speed of x1), 1 x PCIe16
0010-153571	IPC-810E/EC0-1822/i5-10500E/8G/1T/300W	H420E platform motherboard/i5-10500E/8G memory/1T HDD/300W power supply/6 x COM/8 x USB (2 at front, 6 at rear)/2 x Gigabit LAN port/VGA+DP/1 group of audio ports/expansion: 4 x PCI, 2 x PCIe4 (actually providing the speed of x1), 1 x PCIe16
0010-153581	IPC-820/EC0-1822/i7-10700E/8G/1T/300W	H420E platform motherboard/i7-10700E/8G memory/1T hard disk/300W power supply/6 x COM/8 x USB (2 at front, 6 at rear)/2 x Gigabit LAN port/VGA+DP/1 group of audio ports/expansion: 4 x PCI, 2 x PCIe4 (actually providing the speed of x1), 1 x PCIe16
0010-153591	IPC-820/EC0-1822/i9-10900E/16G/1T/256G	H420E platform motherboard/i9-10900E/16G memory/1T HDD+256G SSD/300W power supply/6 x COM/8 x USB (2 at front, 6 at rear)/2 x Gigabit LAN port/VGA+DP/1 group of audio ports/expansion: 4 x PCI, 2 x PCIe4 (actually providing the speed of x1), 1 x PCIe16

Note: The final interpretation rights for product specifications, ordering information, etc. belong to EVOC Intelligent Technology Co., Ltd.

EC0-1823

ATX Structure Motherboard

EC0-1823 motherboard adopts standard ATX specifications and Intel 470E&W480E chipset, and supports LGA 1200 pin 10/11 Gen processors. It provides 4 DDR4 DIMM memory slots, expandable up to 128 GB, supports high-speed USB 3.2 Gen2 port, 10Gb/S broadband rate, and supports PCI+PCIE expansion combination, multiple COM ports, multiple USB ports, and AMT remote management function. It can be widely used in industrial automation, machine vision, deep learning, safety monitoring, intelligent transportation, environmental protection, communication and other fields.



Product Features



Supports Intel 10th Gen processors

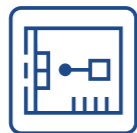

ATM remote management



14 x USB port



2 x PCI+
5 x PCIe expansion

Product Dimensions Drawing

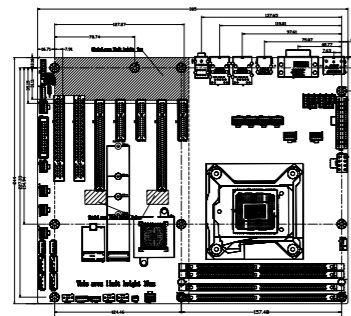

Please refer to the user manual to check detailed specifications and dimension. (Unit: MM)

Product Specifications

Item	Description
Processor	Q470E chipset: supports Intel LGA1200 pin 10/11th Gen processors, power consumption up to 125W W480Echipset: supports Intel LGA1200 pin 10/11th Gen processors, Xeon W series processors, power consumption up to 125W
Chipset	Q470E/W480E
Memory	4 x DDR4 DIMM memory slot, a single memory module supporting 32GB, the four supporting up to 128GB
Display Ports	VGA, DVI-D, DP triple display
Audio Ports	Supports MIC-IN/LINE-OUT
LAN	2 x Gigabit LAN port, LAN1 supporting Wake-on-LAN
Storage	5 x SATA3.0, supporting RAID 0, 1, 5, 10
IO Ports	6 x COM port, COM1, COM2 support RS-232/RS-422/RS-485 mode selection 8 x USB2.0, 4 x USB3.2 GEN1 (5Gb/s), 2 x USB3.2 GEN1 (10Gb/s) 1 x PS/2 port 1 x 8-channel digital I/O port 1 x TPM port
Bus Expansion	2 x PCI, 3 x PCIe4 2 x PCIe16 (when the two PCIe slots are occupied at same time, PCIe8 speed is used) 1 x M.2 KEY M port (PCIe3.0 X4 and SATA signal)
Power Supply	ATX power supply
Working Environment	-10°C~60°C
Storage Environment	-40°C~85°C
Constant Damp Heat	40°C 95%RH, non-condensing
Dimensions	305mm (L)×244mm (W)
Operating System	WIN10, WINServer 2019, Linux high kernel version

Ordering Information

Part No.	Model	Description
0030-023841	EC0-1823-03	ATX structure motherboard/Q470E chipset/supports Intel 10/11 Gen processors/provides 4 x DDR4 DIMM memory slot, supporting expansion up to 128GB/VGA+DP+DVI-D triple display/5 x SATA3.0, supporting Raid 0, 1, 5, 10/1 x M.2/2 x Gigabit LAN port/14 x USB/6 x COM/supports MIC-IN/LINE-OUT/1 x 8-channel GPIO/1 x TPM/1 x LPT/1 x LPC/expansion: 2 x PCI, 2 x PCI E x16, 3 x PCI E x4
0030-023851	EC0-1823-04	ATX structure motherboard/W480E chipset/supports Intel LGA1200 pin 10/11 Gen processors, Xeon W series processors/provides 4 x DDR4 DIMM memory slot, supporting up to 128GB/VGA+DP+DVI-D triple display/5 x SATA3.0, supporting Raid 0, 1, 5, 10/1 x M.2/2 x Gigabit LAN port/14 x USB/6 x COM/supports MIC-IN/LINE-OUT/1 x 8-channel GPIO/1 x TPM/1 x LPT/1 x LPC/expansion: 2 x PCI, 2 x PCI E x16, 3 x PCI E x4
0020-066471	IPC-810/EC0-1823-03/300W	Q470E platform motherboard/300W power supply/1 x COM/10 x USB (2 at front, 8 at rear)/2 x Gigabit LAN port/VGA+DP+DVI-D/1 group of audio port/ expansion: 2 x PCI, 2 x PCIe x16, 3 x PCIe x4
0020-066481	IPC-860/EC0-1823-03/600W	Q470E platform motherboard/600W power supply/1 x COM/10 x USB (2 at front, 8 at rear)/2 x Gigabit LAN port/VGA+DP+DVI-D/1 group of audio port/ expansion: 2 x PCI, 2 x PCIe x16, 3 x PCIe x4
0020-066491	IPC-860/EC0-1823-03/1000W	Q470E platform motherboard/1000W power supply/1 x COM/10 x USB (2 at front, 8 at rear)/2 x Gigabit LAN port/VGA+DP+DVI-D/1 group of audio port/ expansion: 2 x PCI, 2 x PCIe x16, 3 x PCIe x4
0020-066501	IPC-860/EC0-1823-04/1000W	W480E platform motherboard/1000W power supply/1 x COM/10 x USB (2 at front, 8 at rear)/2 x Gigabit LAN port/VGA+DP+DVI-D/1 group of audio port/ expansion: 2 x PCI, 2 x PCIe x16, 3 x PCIe x4
0010-169231	IPC-810E/EC0-1823-03/i5-10500/8G/1T/300W	Q470E platform motherboard/i5-10500/8G memory/1T HDD/300W power supply/6 x COM/10 x USB (2 at front, 8 at rear)/2 x Gigabit LAN port/VGA+DP+DVI-D/1 group of audio port/expansion: 2 x PCI, 2 x PCIe x16, 3 x PCIe x4
0010-169241	IPC-820/EC0-1823-03/i7-10700/16G/1T/256G	Q470E platform motherboard/i7-10700/16G memory/1T HDD+256G SSD/300W power supply/6 x COM/10 x USB (2 at front, 8 at rear)/2 x Gigabit LAN port/VGA+DP+DVI-D/1 group of audio port/expansion: 2 x PCI, 2 x PCIe x16, 3 x PCIe x4

Note: The final interpretation rights for product specifications, ordering information, etc. belong to EVOC Intelligent Technology Co., Ltd.

EC0-1825

ATX Structure motherboard

EC0-1825 motherboard adopts standard ATX specifications and Intel H610E chipset, supports Intel's 12th Gen processors, PCI+PCIE expansion combination, multiple COM ports, and multiple USB ports. It can be widely used in industrial automation, machine vision, deep learning, safety monitoring, intelligent transportation, environmental protection, communication and other fields.



Product Features

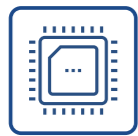

Supports 12th Gen processors

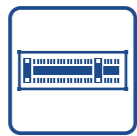

Supports PCI E5.0

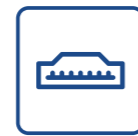

Supports HDMI2.0b high definition display



Provides 1 x 2500Mbps LAN port

Product Dimensions Drawing

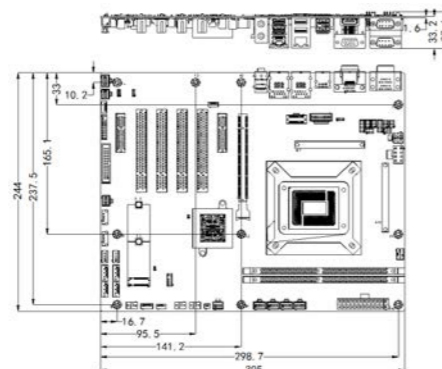

Please refer to the user manual to check detailed specifications and dimension. (Unit: MM)

Product Specifications

Item	Description
Processor	Supports Intel LGA1700 pin 12th Gen processors, power consumption up to 125W
Chipset	H610E
Memory	2 x DDR4 DIMM memory slot, a single memory module supporting 32GB, the two supporting up to 64GB
Display Ports	VGA, DVI-D, HDMI2.0b triple display
Audio Ports	Supports MIC-IN/LINE-OUT
LAN	1 x 10/100/1000Mbps LAN port 1 x 10/100/1000/2500Mbps LAN port LAN1 supports Wake-on-LAN
Storage	4 x SATA3.0
IO Ports	6 x COM port, COM1, COM2 support RS-232/RS-422/RS-485 mode selection 6 x USB2.0, 4 x USB3.0 1 x PS/2 port 1 x 8-channel digital I/O port 1 x TPM port
Bus Expansion	4 x PCI 1 x PCIe x16 (supporting up to PCIe5.0) 1 x PCIe x4 (bit number PCIe1, PCIe3.0 x2 signal) 1 x PCIe x4 (bit number PCIe2, PCIe3.0 x2 signal or PCIe3.0 x4 signal) 1 x M.2 KEY M port (PCIe3.0 x2 signal, size 2242/2280) Note: As compatible cable design is adopted for M.2 and PCIe2 slot, when M.2 device is not inserted, PCIe2 slot provides PCIe3.0 x4 signal
Power Supply	ATX power supply
Working Environment	-10°C~60°C
Storage Environment	-40°C~85°C
Constant Damp Heat	40°C 95%RH, non-condensing
Dimensions	305mm(L)×244mm(W)
Operating System	Windows 10 (Windows 10(21H1) and later versions are required), WIN11, high kernel version LINUX systems (kernel versions 5.15 and above are required)

Ordering Information

Part No.	Model	Description
0030-024141	EC0-1825-01	ATX structure single board/H610E chipset/supports 12th Gen processors/provides 2 x DDR4 DIMM memory slot, supporting expansion up to 64GB/VGA+HDMI+DVI-D triple display/4 x SATA3.0/1 x M.2/2 x Gigabit LAN port/6 x USB2.0, 4 x USB3.0/6 x COM/MIC-IN/LINE-OUT/1 x 8-channel GPIO/1 x TPM/1 x LPT/4 x PCI, 1 x PCIe4.0 x16, 2 x PCIe3.0 x4 slot (pay attention to PCIe x4 speed signal matching)
0030-024121	EC0-1825-02	ATX structure single board/H610E chipset/supports 12th Gen processors/provides 2 x DDR4 DIMM memory slot, supporting expansion up to 64GB/VGA+HDMI+DVI-D triple display/4 x SATA3.0/1 x M.2/2 x Gigabit LAN port/6 x USB2.0, 4 x USB3.0/6 x COM/MIC-IN/LINE-OUT/1 x 8-channel GPIO/1 x TPM/1 x LPT/4 x PCI, 1 x PCIe5.0 x16, 2 x PCIe3.0 x4 (pay attention to PCIe x4 speed signal matching)
0020-066901	IPC-810/EC0-1825/300W	4U, 19"standard rack mount IPC-810 barebone system/EC0-1825-01/ATX300W power supply/no optical drive/no keyboard and mouse/with heat sink, external ports: 2 x Gigabit LAN port/2 x COM port/8 x USB/VGA+HDMI+DVI-D triple display/MIC-IN/LINE-OUT/4 x PCI, 1 x PCIe4.0 x16, 2 x PCIe3.0 x4 (pay attention to PCIe x4 speed signal matching)
0010-176481	IPC-810E/EC0-1825/i5-12500/8G/1T/300W	4U, 19"standard rack mount IPC-810E complete PC/EC0-1825-01/i5-12500/8G memory/1T HDD/ATX 300W power supply/no optical drive/no keyboard and mouse, external ports: 2 x Gigabit LAN port/6 x COM port/8 x USB/VGA+HDMI+DVI-D triple display/MIC-IN/LINE-OUT/4 x PCI, 1 x PCIe4.0 x16, 2 x PCIe3.0 x4 (pay attention to PCIe x4 speed signal matching)
0010-176491	IPC-820/EC0-1825/i7-12700/8G/1T/300W	4U, 19"standard rack mount IPC-820 complete PC/EC0-1825-01/i7-12700/8G memory/1T HDD/ATX 300W power supply/no optical drive/no keyboard and mouse, external ports: 2 x Gigabit LAN port/6 x COM port/8 x USB/VGA+HDMI+DVI-D triple display/MIC-IN/LINE-OUT/4 x PCI, 1 x PCIe4.0 x16, 2 x PCIe3.0 x4 (pay attention to PCIe x4 speed signal matching)

Note: The final interpretation rights for product specifications, ordering information, etc. belong to EVOC Intelligent Technology Co., Ltd.

EPE-1816

EPE Bus Standard Full-length Card

EPE-1816 is a full-length CPU card that is developed based on Intel H110 platform and complies with the PICMG1.3 bus standard. It supports 6/7th Gen processors in the LGA1151 package, two 288Pin DDR4 memory slots (supporting up to 32GB memory capacity), and onboard 2 x 10/100/1000Mbps LAN port, and has the characteristics of high performance and long lead time. It can be widely used in fields such as petrochemical industry, automation control, automatic testing, machine vision, safety monitoring, intelligent transportation, and communication.



Product Features



EPE rugged bus

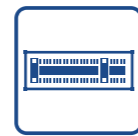

Supports 2 x memory slot

Product Dimensions Drawing

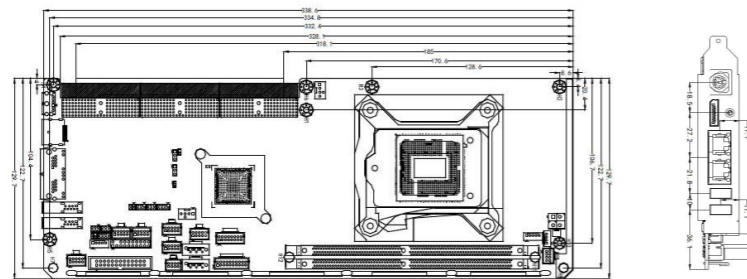

Please refer to the user manual to check detailed specifications and dimension. (Unit: MM)

Product Specifications

Item	Description
Processor	Supports Intel LGA 1151 pin 6/7th Gen processors
Chipset	H110
Memory	2 x DDR4 DIMM memory slot, a single memory module supporting 16GB, and the two supporting up to 32GB
Display Ports	Any two display ports among VGA, DP, DVI-D DP is an onboard coastline interface
Audio Ports	Supports MIC-IN/LINE-IN/LINE-OUT
LAN	2 x 10/100/1000Mbps LAN port, LAN1 supporting Wake-on-LAN
Storage	4 x SATA2.0
IO Ports	10 x USB2.0 2 x COM port, supporting RS-232/RS-422/RS-485 mode selection 1 x parallel port 1 x PS/2 port 1 x 8-channel digital I/O port
Bus Expansion	EPE bus expansion, supporting EPE series carrier boards; and H110 platform does not support ISA expansion slot
Power Supply	ATX power supply
Working Environment	-10°C~60°C
Storage Environment	-20°C~80°C
Constant Damp Heat	40°C 95%RH, non-condensing
Dimensions	352.2mm (L)×141.6mm (W)×77.4mm (H)
Operating System	Win7, Win10, Linux

Ordering Information

Part No.	Model	Description
0030-022981	EPE-1816(B)	PICMG 1.3 standard full-length card/H110 platform/supports Intel LGA1151 pin 6/7th Gen processors/2 x DDR4 DIMM memory slot, supporting up to 32GB memory/2 x Gigabit LAN port/4 x SATA2.0/10 x USB2.0/2 x COM port/supports any two display ports among DP, VGA, DVI-D/1 x LPT Note: H110 platform does not support ISA expansion slot

Note: H110 platform don't support ISA expansion, ISA won't recognize.

Note: The final interpretation rights for product specifications, ordering information, etc. belong to EVOC Intelligent Technology Co., Ltd.

EPE-1815

EPE Bus Standard Full-length Card

EPE-1815 is a full-length card that is developed based on Intel H61 platform and complies with the PICMG1.3 bus standard. It supports 2nd/3rd Gen processors, two DDR3 memory modules (supporting up to 16GB), and EPE rugged bus design, which features reliability and stability. The card can be widely used in fields such as automation control, automatic testing, petrochemical industry, intelligent transportation, safety monitoring and machine vision.



Product Features

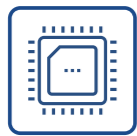

Supports Intel 2nd/3rd Gen processors



EPE rugged bus

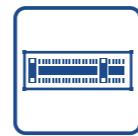

Supports 2 x memory slot

Product Dimensions Drawing

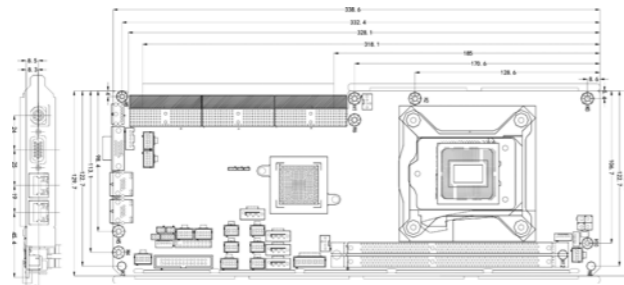

Please refer to the user manual to check detailed specifications and dimension. (Unit: MM)

Product Specifications

Item	Description
Processor	Supports Intel LGA 1155 pin 2nd/3rd Gen processors
Chipset	H61
Memory	2 x DDR3 DIMM memory slot, a single memory module supporting 8GB, and the two supporting up to 16GB
Display Ports	VGA, DVI-D dual display
Audio Ports	Supports MIC-IN/LINE-IN/LINE-OUT
LAN	2 x 10/100/1000Mbps LAN port, LAN1 supporting Wake-on-LAN
Storage	4 x SATA2.0
IO Ports	10 x USB2.0 2 x COM port, among them COM1 supports RS-232/RS-422/RS-485 mode selection 1 x parallel port 1 x PS/2 port 1 x 8-channel digital I/O port
Bus Expansion	EPE bus expansion, supporting EPE series carrier boards
Power Supply	ATX power supply
Working Environment	0°C~60°C
Storage Environment	-20°C~80°C
Constant Damp Heat	40°C 95%RH, non-condensing
Dimensions	340.6mm (L)×145.7mm (W)×77.4mm (H)
Operating System	WINXP, WINXPE, WIN7, LINUX systems

Ordering Information

Part No.	Model	Description
0030-020021	EPE-1815VNA-H61	PICMG 1.3 standard full-length card/H61 platform/supports Intel LGA1155 pin 2nd/3rd Gen processors/2 x DDR3 DIMM memory slot, supporting up to 16GB/1 x Gigabit LAN port/4 x SATA2.0/10 x USB2.0/2 x COM port/VGA+DVI-D dual display
0030-019991	EPE-1815V2NA-H61	PICMG 1.3 standard full-length card/H61 platform/supports Intel LGA1155 pin 2nd/3rd Gen processors/2 x DDR3 DIMM memory slot, supporting up to 16GB/2 x Gigabit LAN port/4 x SATA2.0/10 x USB2.0/2 x COM port/VGA+DVI-D dual display

Note: The final interpretation rights for product specifications, ordering information, etc. belong to EVOC Intelligent Technology Co., Ltd.

EPE Backplane Selection Guide

EPE-6113E4(V) 13-slot EPE backplane

Part No.	Model	Description
0050-001661	EPE-6113E4(V)	13-slot EPE backplane, 1 x main slot/8 x PCI / 1 x PCIe ×16/3 x PCIe×1, 2 x SATA, 4 x USB2.0, two of which are pins lead, two of which lead by 180° vertical connector, provide 1 x ATX24PIN power port, support ACPI power management, AT power 12PINs port reserved

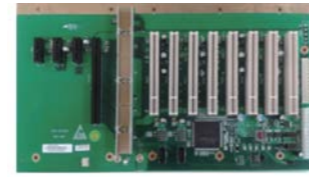

EPE-6110E5(V) 10-slot EPE backplane

Part No.	Model	Description
1050-004641	EPE-6110E5(V)	10-slot EPE PCIe/PCI backplane, 1 x main slot /4 x PCI/1 x PCIe×16 /4 x PCIe×1, 2 x SATA, 4 x USB2.0, two of which are pins lead, two of which lead by a 180° vertical connector, provide 1 x ATX 24PIN power port, support ACPI power management, AT power 12PINs port reserved.



EPE-6105E2(V) 5-slot EPE backplane

Part No.	Model	Description
1050-004651	EPE-6105E2(V)	5-slot EPE backplane, 1 x main slot / 2 x PCI / 1 x PCIe ×16 / 1 x PCIe×1, 2 x SATA, 4 x USB2.0, two of which are pins lead, two of which lead by 180° vertical connector, provide 1 x ATX 24 PIN power port, support ACPI power management, AT power 12PINs port reserved.



EPE-6105E1 5-slot EPE backplane

Part No.	Model	Description
0050-001471	EPE-6105E1	5-slot EPE backplane, 1 x main slot/3 x PCI/1 x PCIe ×16, 2 x SATA, 4 x USB2.0, two of which are pins lead, two of which lead by 180° vertical connector, provide 1 x ATX 24PIN power port, support ACPI power management



EPE-6109E2 9-slot EPE backplane

Part No.	Model	Description
0050-001531	EPE-6109E2	9-slot EPE backplane, 1 x main slot/6 PCI/1 x PCIe ×16/ 1 x PCIe ×1, 2 x SATA, 4 x USB2.0, two of which are pins lead, two of which lead by 180° vertical connector, provide 1 x ATX 24 PIN power port, support ACPI power management, AT power 12PIN port is reserved.



EPE-6109E4 9-slot EPE backplane

Part No.	Model	Description
0050-001551	EPE-6109E4	9-slot EPE PCI/PCIE backplane, 1 x main slot/4 x PCI/4 x PCIe ×1, 2 x SATA, 4 x USB2.0, two of which are pins lead, two of which lead by 180°vertical connector, provide 1 x ATX 24 PIN power port, support ACPI power management

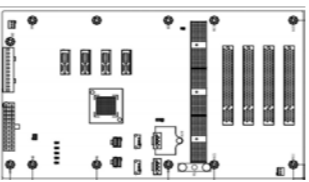

EPE-6113E2 13-slot EPE backplane

Part No.	Model	Description
0050-001461	EPE-6113E2	13-slot EPE PCIe/PCI backplane, 1 x main slot/10 x PCI / 1 x PCIe ×16/1 x PCIe ×4(PCI-E×1 when equipped with H61 motherboard), 2 x SATA, 4 x USB2.0, two of which are pins lead, two of which lead by 180° vertical connector, 1 x ATX 24 PIN power port, supporting ACPI power management



Note: The final interpretation rights for product specifications, ordering information, etc. belong to EVOC Intelligent Technology Co., Ltd.

EPE Backplane Selection Guide

EPE-6105P2 5-slot EPE backplane

Part No.	Model	Description
0050-001581	EPE-6105P2	5-slot EPE backplane, 1 x main slot / 2 x PCI / 2 x ISA, 2 x SATA, 4 x USB2.0, two of which are pins lead, two of which lead by 180° vertical connectors, Provide 1 x ATX 24 PIN power port, support ACPI power management



EPE-6111P6 11-slot EPE backplane

Part No.	Model	Description
1050-004621	EPE-6111P6	11-slot EPE PCIe/PCI/ISA backplane, 1 x main slot / 6 x PCI / 1 x PCIe ×16(if the PCIe card is inserted, the near PCI slot cannot be used) / 3 x ISA slots, 2 x SATA, 4 x USB2.0, two of which are pins lead, other two are led by 180° vertical connectors, provide 1 x ATX 24 PIN power port, support ACPI power management



EPE-6111P8 11-slot EPE backplane

Part No.	Model	Description
0050-001491	EPE-6111P8	11-slot EPE backplane, 1 x main slot/8 x PCI(EU connector) / 2 x ISA slots(EU connector), 2 x SATA, 4 x USB2.0, two of which are pins lead, other two are led by 180° vertical connector, provide 1 x ATX 24 PIN power port, support ACPI power management

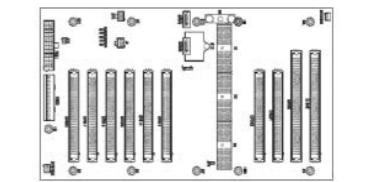

EPE-6112E5 12-slot EPE backplane

Part No.	Model	Description
0050-001611	EPE-6112E5	12-slot EPE PCI/PCIE backplane, 1 x main slot / 6 x PCI / 4 x PCIe ×4, 2 x SATA3.0, 4 x USB2.0, two of which are pins lead, and 2 are 180°vertical connector lead, provide 1 x ATX 24 PIN power port, support ACPI power management



EPE-6111E6P4 11-slot EPE backplane

Part No.	Model	Description
1050-005521	EPE-6111E6P4	11-slot EPE backplane, extend 4 x PCI, 4 x PCIe x4, 2 x PCIe x16, provide 4 x USB2.0, two of which are 2×4 Wafer form, and the other two as vertical 90°type connector, 2 x SATA, 1 x ATX 24Pin power port, supporting ACPI power management.

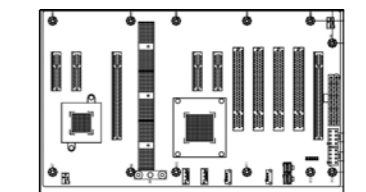

Note: The final interpretation rights for product specifications, ordering information, etc. belong to EVOC Intelligent Technology Co., Ltd.

EC7-1821

Mini-ITX Motherboard

EC7-1821 motherboard is a standard Mini-ITX motherboard which adopts H110 chipset and supports 6th/7th Gen processors in the LGA1151 package. It has one vertical insertion USB port onboard, supports expansion to encryption devices, multiple COM ports, multiple U ports, and dual Gigabit LAN ports, and provides one PCIe x16 expansion port. The motherboard is widely used in industries such as banking, taxation, ETC, industrial manufacturing, and machine vision.



Product Features



Supports Intel 6/7th processor



VGA+HDMI dual display



6 x COM port

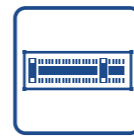

8 x USB port

Product Dimensions Drawing

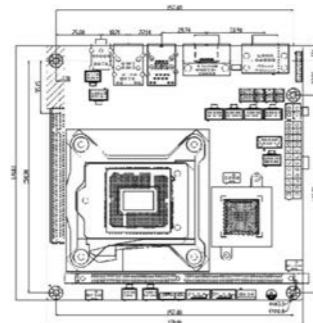

Please refer to the user manual to check detailed specifications and dimension. (Unit: MM)

Product Specifications

Item	Description
Processor	Supports Intel LGA 1151 pin 6/7th Gen processors
Chipset	H110
Memory	1 x DDR4 DIMM memory slot, the single memory slot supporting 16GB
Display Ports	VGA, HDMI dual display
Audio Ports	Supports MIC-IN/LINE-OUT
LAN	2 x 10/100/1000Mbps LAN port
Storage	2 x SATA3.0
IO Ports	6 x COM port, COM1, COM2 support RS-232/RS-422/RS-485 mode selection 4 x USB2.0, 4 x USB3.0 1 x 16-channel digital I/O port
Bus Expansion	1 x PCIe16
Power Supply	ATX power supply
Working Environment	0°C~50°C
Storage Environment	-20°C~60°C
Constant Damp Heat	40°C 95%RH, non-condensing
Dimensions	170mm (L) x 170mm (W)
Operating System	WIN7, WIN10, LINUX systems

Ordering Information

Part No.	Model	Description
0030-021911	EC7-1821-H110S	Mini-ITX structure motherboard/H110 platform/supports LGA1151 pin 6/7th Gen processor/1 x DDR4 memory slot, supporting up to 16GB/VGA+HDMI dual display/2 x Gigabit LAN port/4 x USB2.0/4 x USB3.0/6 x COM port/2 x SATA3.0/1 x 16-channel GPIO/LIN-IN/LIN-OUT/1 x PCIe16

Note: The final interpretation rights for product specifications, ordering information, etc. belong to EVOC Intelligent Technology Co., Ltd.

EC7-1823

Mini-ITX Motherboard

EC7-1823 is a standard Mini-ITX motherboard which adopts BayTrail platform J1900 low-power platform, onboard two 10/100/1000Mbps LAN ports having lightning-proof function, supports multiple display ports, multiple U ports, multiple COM ports, and provides one PCIE x16 expansion port (actually providing the speed of *1), one Mini-pcie port (supporting expansion to 3G, 4G and Wifi module), one SIM card slot and one M-Sata interface. The motherboard can be widely used in industries such as banking, taxation, and automation.



Product Features

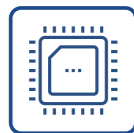

Onboard low-power processors



Supports expansion to 3G, 4G and expansion to Wifi module



Multiple IO ports

Product Dimensions Drawing

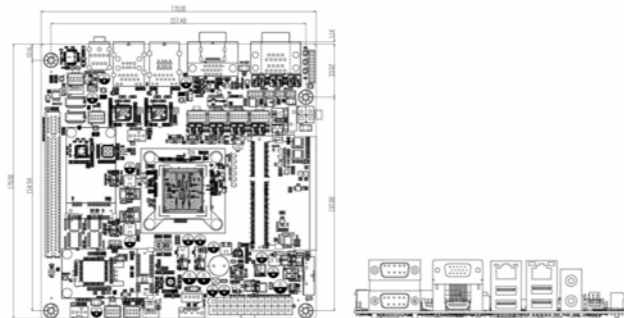

Please refer to the user manual to check detailed specifications and dimension. (Unit: MM)

Product Specifications

Item	Description
Processor	Onboard J1900 quad-core processor
Chipset	BayTrail
Memory	1 x 204 Pin DDR3L SO-DIMM memory slot, supporting up to 8GB
Display Ports	Any two display ports among VGA, HDMI, LVDS
Audio Ports	Supports MIC-IN/LINE-OUT
LAN	2 x 10/100/1000Mbps LAN port
Storage	1 x SATA2.0
IO Ports	6 x COM port 6 x USB2.0, 1 x USB3.0 1 x 16-channel I/O port 1 x Mini-pcie port 1 x SIM card slot 1 x MSATA interface
Bus Expansion	1 x PCIe16 (actually providing the speed of x1)
Power Supply	Single 12V power supply
Working Environment	-10°C~60°C
Storage Environment	-20°C~85°C
Constant Damp Heat	40°C 95%RH, non-condensing
Dimensions	170mm (L)×170mm (W)
Operating System	WIN7, WIN10, LINUX systems

Ordering Information

Part No.	Model	Description
0030-022081	EC7-1823-J1900	Mini-ITX structure motherboard/onboard J1900 processor/1 x DDR3L SO-DIMM memory slot, supporting up to 8GB/any two display ports among VGA, HDMI, LVDS/2 x Gigabit LAN port/6 x USB2.0/1 x USB3.0/6 x COM port/1 x SATA3.0/1 x 16-channel GPIO/MIC-IN/LIN-OUT/1 x PCIe16(actually providing the speed of x1)/1 x Mini-pcie port/1 x SIM card slot/1 x MSATA
0030-022191	EC7-1823-J1900SP	Mini-ITX structure motherboard/onboard J1900 processor/1 x DDR3L SO-DIMM memory slot, supporting up to 8GB/ny two display ports among VGA, LVDS, HDMI/2 x Gigabit LAN port/6 x USB2.0/1 x USB3.0/6 x COM port/1 x SATA3.0/1 x 16-channel GPIO/MIC-IN/LIN-OUT/1 x PCIe16(actually providing the speed of x1)/1 x Mini-pcie port/1 x SIM card slot/1 x MSATA/single 12V 4pin port/PS2 brought out via wafer
0030-022681	EC7-1823-DC	Mini-ITX structure motherboard/onboard J1900 processor/1 x DDR3L SO-DIMM memory slot, supporting up to 8GB/any two display ports among VGA, LVDS, HDMI/2 x Gigabit LAN port/6 x USB2.0/1 x USB3.0/6 x COM port/1 x SATA3.0/1 x 16-channel GPIO/MIC-IN/LIN-OUT/1 x PCIe16(actually providing the speed of x1)/1 x Mini-pcie port/1 x SIM card slot/1 x MSATA/DC round connector/PS2 port onboard

Note: The final interpretation rights for product specifications, ordering information, etc. belong to EVOC Intelligent Technology Co., Ltd.

EC3-1820

3.5" Single Board Computer

EC3-1820V2NA is a low-power embedded motherboard that is developed based on Intel Bay Trail platform and complies with 3.5" single board specifications. This product adopts Intel's low-power solution, and its small form factor design is suitable for applications in mechanical control, power, medical equipment, and various instruments and meters.



Product Features

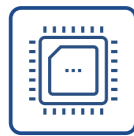

Onboard low-power processors

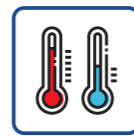

Optional wide-temperature environment



Multiple IO ports

Product Dimensions Drawing

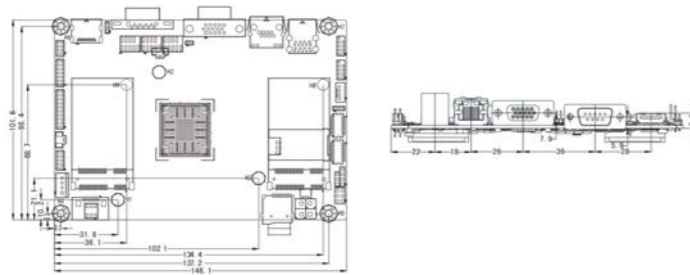

Please refer to the user manual to check detailed specifications and dimension. (Unit: MM)

Product Specifications

Item	Description
Processor	Onboard E3845, J1900 quad-core processor
Chipset	BayTrail
Memory	Onboard 4G memory
Display Ports	VGA, HDMI, LVDS
Audio Ports	Supports MIC-IN/LINE-IN/LINE-OUT
LAN	2 x 10/100/1000Mbps LAN port
Storage	1 x SATA, 1 x mSATA optional, 1 x Micro SD card slot (not supported by J1900)
IO Ports	4 x COM port, COM1, COM2 support RS-232/RS-422/RS-485 mode selection 6 x USB2.0 2 x 8-channel digital I/O port 1 x PS/2 port
Bus Expansion	1 x Mini-pcie port
Power Supply	Single 12V power supply
Working Environment	0°C~60°C (standard configuration) , expandable temperature range: -40°C~85°C (optional)
Storage Environment	-40°C~85°C
Constant Damp Heat	40°C 95%RH, non-condensing
Dimensions	146.1mm (L)×101.6mm (W)×25mm (H)
Operating System	WIN7, WIN8, LINUX systems

Ordering Information

Part No.	Model	Description
0030-023731	EC3-1820V2NA(D)-E3845	3.5" single board/onboard E3845 quad-core processor/onboard 4GB DDR3 memory/VGA, HDMI, LVDS/1 x PS2 port/2 x 8-channel GPIO/6 x USB2.0/1 group of audio ports/2 x LAN port/1 x M-SATA/1 x SD/1 x SATA/4 x COM port/1 x MiniPCIE port
0030-023741	EC3-1820V2NA(D)-J1900	3.5" single board/onboard J1900 quad-core processor/onboard 4GB DDR3 memory/VGA, HDMI, LVDS/1 x PS2 port/2 x 8-channel GPIO/6 x USB2.0/1 group of audio ports/2 x LAN port/1 x M-SATA/1 x SATA/4 x COM port/1 x MiniPCIE port

Note: The final interpretation rights for product specifications, ordering information, etc. belong to EVOC Intelligent Technology Co., Ltd.

EC3-1821

3.5" Single Board Computer

EC3-1821 is a standard 3.5" motherboard which contains onboard Intel high-performance low-power Skylake-U series processors, has multiple IO ports, supports multiple display ports, multiple U ports, multiple COM ports, one Mini-pcie port, one SIM card slot, one M-Sata interface and one self-defined expansion port. The motherboard can be widely used in industries such as machine vision, intelligent robot, medical care, and automation.



Product Features

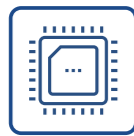

Onboard low-power processors



Multiple IO ports



Self-defined expansion port

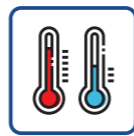

Optional wide-temperature environment

Product Dimensions Drawing

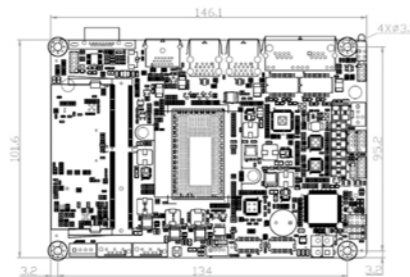

Please refer to the user manual to check detailed specifications and dimension. (Unit: MM)

Product Specifications

Item	Description
Processor	Onboard I7-6600U 2.6Ghz, I5-6300U 2.4Ghz, I3-6100U 2.3Ghz, 3955U 2.0Ghz processors
Chipset	SkyLake-U
Memory	1 x 260Pin DDR4 memory slot, supporting up to 16G
Display Ports	VGA, HDMI, LVDS
Audio Ports	Supports MIC-IN/LINE-IN/LINE-OUT
LAN	2 x 10/100/1000Mbps LAN port
Storage	2 x SATA3.0 port, 1 x mSATA
IO Ports	2 x COM port, supporting RS-232/RS-422/RS-485 mode selection 4 x USB3.0, 2 x USB2.0 1 x 8-channel digital I/O port
Bus Expansion	1 x Mini-pcie port, 1 x SIM card slot, 1 x self-defined expansion port
Power Supply	Single 12V power supply
Working Environment	0°C~60°C (standard configuration) , expandable temperature range: -40°C~85°C (optional)
Storage Environment	-40°C~85°C
Constant Damp Heat	40°C 95%RH, non-condensing
Dimensions	146.1mm (L)×101.6mm (W)×26.7mm (H)
Operating System	WIN7, WIN10, LINUX systems

Ordering Information

Part No.	Model	Description
0030-022211	EC3-1821-3955U	3.5" single board/onboard 3955U processor/1 x 260Pin DDR4 memory slot, supporting up to 16G/2 x SATA3.0/1 x M-sata/VGA+LVDS+HDMI/2 x Gigabit LAN port/2 x COM port/1 group of audio ports/4 x USB3.0, 2 x USB2.0/1 x Mini-pcie port/1 x SIM card slot/1 x 8-channel digital I/O port/1 x self-defined expansion port
0030-022151	EC3-1821-I36100U	3.5" single board/onboard I36100U processor/1 x 260Pin DDR4 memory slot, supporting up to 16G/2 x SATA3.0/1 x M-sata/VGA+LVDS+HDMI/2 x Gigabit LAN port/2 x COM port/1 group of audio ports/4 x USB3.0, 2 x USB2.0/1 x Mini-pcie port/1 x SIM card slot/1 x 8-channel digital I/O port/1 x self-defined expansion port
0030-022221	EC3-1821-I56300U	3.5" single board/onboard I56300U processor/1 x 260Pin DDR4 memory slot, supporting up to 16G/2 x SATA3.0/1 x M-sata/VGA+LVDS+HDMI/2 x Gigabit LAN port/2 x COM port/1 group of audio ports/4 x USB3.0, 2 x USB2.0/1 x Mini-pcie port/1 x SIM card slot/1 x 8-channel digital I/O port/1 x self-defined expansion port
0030-022231	EC3-1821-I76600U	3.5" single board/onboard I76600U processor/1 x 260Pin DDR4 memory slot, supporting up to 16G/2 x SATA3.0/1 x M-sata/VGA+LVDS+HDMI/2 x Gigabit LAN port/2 x COM port/1 group of audio ports/4 x USB3.0, 2 x USB2.0/1 x Mini-pcie port/1 x SIM card slot/1 x 8-channel digital I/O port/1 x self-defined expansion port

Note: The final interpretation rights for product specifications, ordering information, etc. belong to EVOC Intelligent Technology Co., Ltd.

COM-1817

ComExpress Single Board

COM-1817 motherboard adopts the Type6 standard COM Express Compact Module, INTEL's mature Bay Trail platform, and onboard Intel J1900, E3845, E3825 low-power CPUs. The motherboard has powerful computing capability and can be widely used in communication, automation, medical care and other fields, to meet various needs of customers.

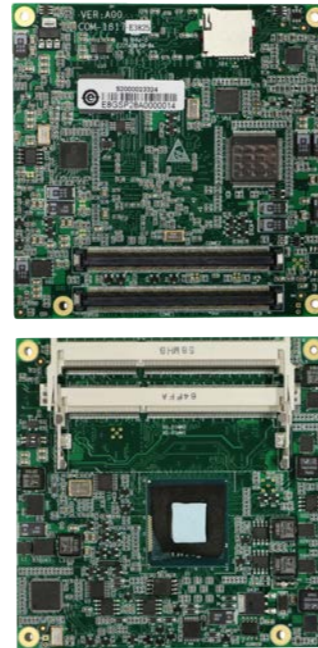

Product Features

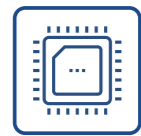

Onboard J1900 processor



Dual-channel memory



Dual-channel display



Supports 8 x USB

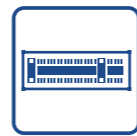

Multiple PCI ports

Product Dimensions Drawing

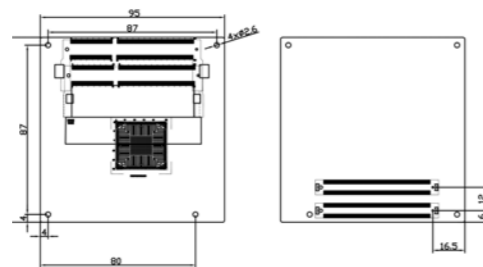

Please refer to the user manual to check detailed specifications and dimension. (Unit: MM)

Product Specifications

Item	Description
Chipset	Onboard J1900 2.0GHz quad-core, E3845 1.9GHz quad-core, E3825 1.33GHz processors
Memory	Intel Bay Trail
Display Ports	Supports dual-channel DDR3L 1333/1600MHz SO-DIMM, UP to 8GB
Audio Ports	Supports VGA, dual-channel 24BIT LVDS, HDMI, DVI, DP multiple display ports
LAN	Supports HDA
Storage	2 x SATA 2.0 interface 1 x SD card port(J1900 has no such port) Onboard 4GB FLASH(optional)
IO Ports	7 x USB2.0 port, 1 x USB 3.0 port, 2 x COM port, 8-channel input/output I/O ports
Bus Expansion	3 x PCI_Ex1, LPC, SMBUS, I2C bus
Working Environment	0°C~60°C(expandable to -40°C~85°C); 5%~95% (non-condensing)
Storage Environment	-40°C~85°C, 5%~95% (non-condensing)
Watchdog	255 level, programmable by second/minute, timeout interrupt or system reset
Power Supply	Single 12V power supply or 5VSB, 12V power supply
Dimensions (W×D×H)	95mm x 95mm

* As for environment, EMC and content of other indexes, the Technical Agreement between the two sides shall prevail.

Ordering Information

Part No.	Model	Description
0030-021051	COM-1817-J1900	COM Express Compact Type 6 module/onboard Intel J1900 2.0GHz quad-core CPU/Bay Trail chipset/supports dual-channel DDR3L memory/VGA, LVDS, HDMI display ports/2×SATA/1 x Gigabit LAN port/7×USB 2.0/1×USB 3.0/2 x RS 232/1×HD A/1x8bit GPIO/3 x PCIe1
0030-021041	COM-1817-E3845	COM Express Compact Type 6 module/onboard Intel E3845 1.91GHz quad-core CPU/ Bay Trail chipset/supports dual-channel DDR3L memory/VGA, LVDS, HDMI display ports/2×SATA/1 x Gigabit LAN port/8×USB 2.0/1×USB 3.0/2 x RS 232/1×HD A/1x8bit GPIO/3 x PCIe1
0030-021031	COM-1817-E3825	COM Express Compact Type 6 module/onboard Intel E3825 1.33GHz dual-core CPU/ Bay Trail chipset/supports dual-channel DDR3L memory/VGA, LVDS, HDMI display ports/2×SATA/1 x Gigabit LAN port/7×USB 2.0/1×USB 3.0/2 x RS 232/1×HD A/1x8bit GPIO/3 x PCIe1
1500-002931	COM-1817 heat sink module	COM-1817 heat sink module
0050-001591	EDB-COM08	Carrier board part No.

Note: The final interpretation rights for product specifications, ordering information, etc. belong to EVOC Intelligent Technology Co., Ltd.

COM-1818

ComExpress Single Board

COM-1818CLNAR motherboard adopts the Type6 standard COM Express Compact Module, INTEL 6th Gen Skylake-U architecture, onboard Intel high-performance low-power Skylake-U series core, and the Celeron 6th Gen processors. The motherboard has powerful computing capability and supports high-performance DDR4 memory. It can be widely used in communication, automation, medical care and other fields, and customers can design and develop their own carrier boards according to their needs.



Product Features

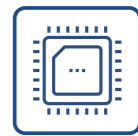

6th Gen processor



Dual-channel DDR4 memory slot



Supports 3-channel independent display



Supports 8 x USB port

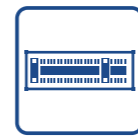

Multiple PCIe ports



Wide-voltage power supply 8.5V-20V

Product Dimensions Drawing

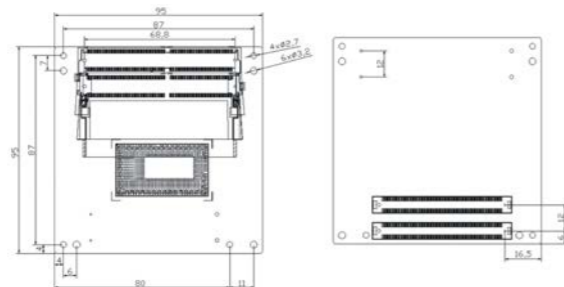

Please refer to the user manual to check detailed specifications and dimension. (Unit: MM)

Product Specifications

Item	Description
Processor	Onboard Intel Celeron 3955U 2.0GHz, Intel Core i3-6100U 2.3GHz, i5-6300U 2.4GHz, i7-6600U 2.6GHz
Chipset	Skylake-U
Memory	Supports dual-channel DDR4 1866/2133MHz SO-DIMM, UP to 32GB (non-ECC)
Display Ports	Supports VGA, LVDS, DDI (expandable to DP/HDMI/DVI via carrier board) and other display ports
Audio Ports	Supports HDA
LAN	1 x 10/100/1000 Mbps LAN port (Intel I219V), supporting Wake-on-LAN
Storage	2 x SATA 3.0 port
IO Ports	4 x USB2.0 port, 4 x USB 3.0 port, 2 x COM port, 4-channel input/4-channel output I/O ports
Bus Expansion	5 x PCIe1; SPI, I2C, SMBUS, LPC and other buses
Working Environment	0°C~60°C(expandable to -40°C~85°C); 5%~95% (non-condensing)
Storage Environment	-40°C~85°C, 5%~95% (Non-condensing)
Watchdog	255 level, programmable by second/minute, timeout interrupt or system reset
Power Supply	8.5V-20V wide-voltage power supply
Dimensions (W×D×H)	95mm x 95mm
Supported Operating Systems	Windows7, Windows8.1, Windows10, Linux

* As for environment, EMC and content of other indexes, the Technical Agreement between the two sides shall prevail.

Ordering Information

Part No.	Model	Description
0030-021801	COM-1818CLNAR-3955U	COM Express Compact Type 6 module/onboard Intel Celeron 3955U 2.0GHzCPU/supports dual-channel DDR4 1866/2133MHz SO-DIMM, UP to 32GB/supports VGA, dual-channel 24BIT LVDS, HDMI, DVI, DP multiple display ports, supporting up to 3 independent display ports/1 x Gigabit LAN port/4 x USB2.0/4 x USB3.0/2 x SATA3.0 /1 x 8-channel GPIO/I2C expansion bus, LPC, SPI, SMBus expansion bus/5*PCIEx1
0030-021811	COM-1818CLNAR-i36100U	COM Express Compact Type 6 module/ onboard Intel Core i3-6100U 2.3GHzCPU/supports dual-channel DDR4 1866/2133MHz SO-DIMM, UP to 32GB/supports VGA, dual-channel 24BIT LVDS, HDMI, DVI, DP multiple display ports, supporting up to 3 independent display ports/1 x Gigabit LAN port/4 x USB2.0/4 x USB3.0/2 x SATA3.0 /1 x 8-channel GPIO/I2C expansion bus, LPC, SPI, SMBus expansion bus/5*PCIEx1
0030-022061	COM-1818CLNAR-i36100U	COM Express Compact Type 6 module/ onboard Intel Core i3-6100U 2.3GHzCPU/supports dual-channel DDR4 1866/2133MHz SO-DIMM, UP to 32GB/self-defined display ports/1 x Gigabit LAN port/4 x USB2.0/4 x USB3.0/2 x SATA3.0 /1 x 8-channel GPIO/I2C expansion bus, LPC, SPI, SMBus expansion bus/5*PCIEx1
0030-021821	COM-1818CLNAR-i56300U	COM Express Compact Type 6 module/ onboard Intel Core i5-6300U 2.4GHzCPU/supports dual-channel DDR4 1866/2133MHz SO-DIMM, UP to 32GB/supports VGA, dual-channel 24BIT LVDS, HDMI, DVI, DP multiple display ports, supporting up to 3 independent display ports/1 x Gigabit LAN port/4 x USB2.0/4 x USB3.0/2 x SATA3.0 /1 x 8-channel GPIO/I2C expansion bus, LPC, SPI, SMBus expansion bus/5*PCIEx1
0030-022051	COM-1818CLNAR-i56300U	COM Express Compact Type 6 module/ onboard Intel Core i5-6300U 2.4GHzCPU/supports dual-channel DDR4 1866/2133MHz SO-DIMM, UP to 32GB/self-defined display ports/1 x Gigabit LAN port/4 x USB2.0/4 x USB3.0/2 x SATA3.0 /1 x 8-channel GPIO/I2C expansion bus, LPC, SPI, SMBus expansion bus/5*PCIEx1
0030-021781	COM-1818CLNAR-i76600U	COM Express Compact Type 6 module/ onboard Intel Core i7-6600U 2.6GHzCPU/supports dual-channel DDR4 1866/2133MHz SO-DIMM, UP to 32GB/supports VGA, dual-channel 24BIT LVDS, HDMI, DVI, DP multiple display ports, supporting up to 3 independent display ports/1 x Gigabit LAN port/4 x USB2.0/4 x USB3.0/2 x SATA3.0 /1 x 8-channel GPIO/I2C expansion bus, LPC, SPI, SMBus expansion bus/5*PCIEx1
0030-021791 (Hytera)	COM-1818CNAR-i76600U	COM Express Compact Type 6 module/ onboard Intel Core i7-6600U 2.6GHzCPU/supports dual-channel DDR4 1866/2133MHz SO-DIMM, UP to 32GB/self-defined display ports/1 x Gigabit LAN port/4 x USB2.0/4 x USB3.0/2 x SATA3.0 /1 x 8-channel GPIO/I2C expansion bus, LPC, SPI, SMBus expansion bus/5*PCIEx1
1500-004391	COM-1818 heat sink module	Including heat-conducting plate, CPU heat sink
0050-001591	EDB-COM08	Carrier board part No.

Note: The final interpretation rights for product specifications, ordering information, etc. belong to EVOC Intelligent Technology Co., Ltd.

JNB-1302P

13.3" Rugged Laptop

JNB-1302P is a 13.3" dual core rugged portable computer. The product meets the requirements of national standards and industry standards such as IP (ingress protection for computer enclosure). Integrating vibration, shock, EMC and other performances, the product is suitable for outdoor use that requires portability, vehicles and other harsh environments. It can meet the requirements of data acquisition, image processing, command and control, and other application scenarios.



Product Features



Thin and light design, portability and reliability



High performance, long endurance



HD screen, sunlight readable

Product Dimensions Drawing

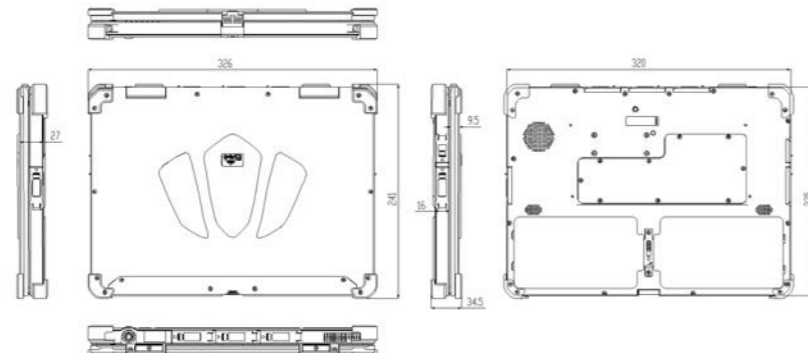

Please refer to the user manual to check detailed specifications and dimension. (Unit: MM)

Product Specifications

Item	Description
Processor	Intel® Core™ i5-6300U 2.4GHz(up to 3.0GHz) dual-core 4-thread Intel® Core™ i7-6600U 2.6GHz(up to 3.4GHz) dual-core 4-thread
Display	13.3" LCD screen, resolution 1920×1080, sunlight readable
Memory	Onboard 8GB DDR4 memory 1 x SO-DIMM expansion memory slot, the PC supporting expansion up to 24GB
Storage	1 x mSATA interface, standard configuration 128G SSD
Graphics Card	Intel HD Graphics 520 integrated display technology
Optical Drive	1 x USB external CD-R drive
IO Ports	1 x HDMI port 2 x RJ-45 10M/100M/1000M self-adaptive Ethernet port 3 x USB3.0 port 2 x RS-232 port(supporting RS-232/422/485 mode via BIOS adjustment selection, RS-232 by default) 1 x Audio standard jack (earphone, MIC two-in-one) 1 x DC power supply input connector (aviation plug)
Expansion Function	1 x Docking expansion port(docking station customizable, supported by only JNB-1302P-01)
Keyboard and Mouse	86-key water-proof plastic keyboard, with left-right keys water-proof touch pad mouse
Audio Function	High-definition audio processor/built-in 2 x speaker/built-in 1 x MIC
Power Adapter	AC power adapter: AC100~240V, DC19V@90W, aviation plug
Battery	2 x 3350mAh intelligent lithium battery (supporting quick assembly and disassembly)
Dimensions	About 320mm(W)×235mm(D)×27mm(H)(excluding corner protectors and handle), allowable error ±1mm
Weight	≤2.3Kg(excluding power adapter and accessories)
Operating System	Supports Windows7, etc.
Indicators	7 x LED indicator 1.Power LED indicator (green) 2.Battery A charging/discharging indicator(green and red) 3.Battery B charging/discharging indicator(green and red) 4.Hard disk working indicator(green) 5.Wireless network working indicator(green) 6.Digital lock indicator(green) 7.Caps Lock indicator(green)
Temperature	Working temperature: - 10°C~ + 50°C Storage temperature: - 20°C~ + 55°C
Damp Heat	Constant damp heat: +40°C, 95%RH
Vibration	Power-on status, sine vibration, 5~15Hz/displacement 1mm, 15-200Hz/1g, X/Y/Z three axes, single vibration time 7Min
Shock	Power-on status, half-sine wave/peak acceleration 10g/duration 11ms, X/Y/Z three axes, 3 times of shock on each axis
Protection Grade	IP54

* As for environment, EMC and other indices, the Technical Agreement between the two parties shall prevail.

Ordering Information

Part No.	Model	Description
0010-126211	JNB-1302P-01	I5-6300U 2.4GHz/8GB DDR4/128GB mSATA/13.3"sunlight readable screen/2*3350mAh battery/plastic keyboard/with Docking port/90W aviation plug adapter
0010-127571	JNB-1302P-02	I7-6600U 2.6GHz/8GB DDR4/128GB mSATA/13.3"sunlight readable screen/2*3350mAh battery/plastic keyboard/90W aviation plug adapter

Note: The final interpretation rights for product specifications, ordering information, etc. belong to EVOC Intelligent Technology Co., Ltd.

JNB-1502P

15.6" Rugged Laptop

JNB-1502P is a 15.6" quad-core rugged portable computer. The product meets the requirements of national standards, IP (ingress protection for computer enclosure) and other industrial standards. Integrating vibration, shock, EMC and other characteristics, the product is suitable for outdoor carrying, vehicles and other harsh environments, and can meet the requirements of application scenarios such as data acquisition, image processing, and command and control.



Product Features



Intel Core 6/7th Gen i7 processors



Optical drive bay multi-expansion function



Reliable safety functions

Product Dimensions Drawing

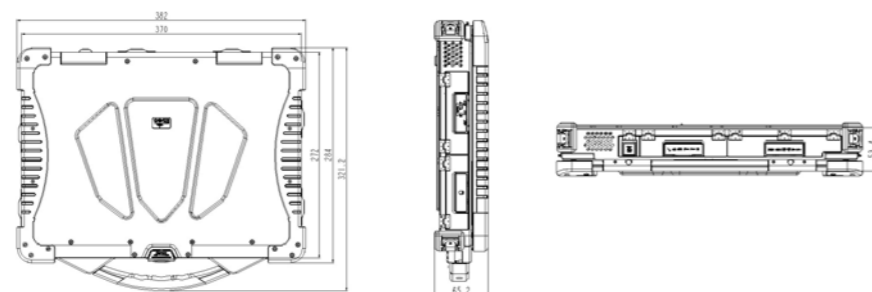

Please refer to the user manual to check detailed specifications and dimension. (Unit: MM)

Product Specifications

Item	Description
Processor	Intel® Core™ i7-7820EQ 3.0GHz(up to 3.7GHz) quad-core 8-thread
Display	15.6" sunlight readable LCD screen, resolution 1920x1080
Memory	Onboard 8GB DDR4 memory 1 x SO-DIMM expansion memory slot, the PC supporting expansion up to 24GB
Storage	1 x 2.5" SATA port, standard configuration 128GB SSD (drawable) 1 x mSATA port, supporting expansion to second storage hard disk
Graphics Card	Supports Intel HD Graphics 630 integrated display technology
Optical Drive	1 x built-in DVD burner drive
IO Ports	1 x VGA port 1 x HDMI port 2 x RJ-45 LAN port 2 x USB3.0 port 2 x USB2.0 port 2 x COM port (supports RS-232/422/485 mode, adjustment and selection by means of BIOS, RS-232 by default) 1 x Line Out audio output port 1 x Mic-In audio input port 1 x DVD optical drive bay 1 x DC power input connector(aviation plug)
Expansion Card Slot	1 x Smart Card slot 1 x SD card reader slot 1 x SIM card slot
Expansion Function	For the optical drive bay, following expansion ports are supported (to be customized): (select one from five)2 x COM port/hard disk/PCIE×1 device/USB port or USB function device/DVD optical drive
Keyboard/mouse	86-key water-proof plastic keyboard, with left/right-key water-proof touch pad mouse
Audio Function	High definition audio processor/built-in 2 x speaker/built-in 1 x MIC
Communication	WLAN (wireless): 802.11a/g/n LAN: 10/100/1000M PAN: Bluetooth 4.0 Class I + EDR
Safety	Administrator password, power-on password Anti-theft pin hole
Power Adapter	AC power adapter: Input AC100~240V, Output DC19V@180W, aviation plug
Battery	6600mAH drawable intelligent lithium battery
Dimensions	About 370mm(W)×272mm(D)×53.4mm(H)(excluding corner protectors and handle), allowable error ±1mm
Weight	≤5.5kg(including single battery, excluding power adapter and accessories)
Operating System	Supports Windows7, etc.
Indicators	7 x LED indicator 1.Power LED indicator (green) 2.Main battery charging/discharging indicator(green and red) 3.Auxiliary battery charging/discharging indicator(green and red) 4.Hard disk working indicator(green) 5.Wireless network working indicator(green) 6.Digital lock indicator(green) 7.Caps Lock indicator(green)
Temperature	Working temperature: - 10°C~ + 50°C (power supply by the adapter) Storage temperature: - 20°C~ + 55°C
Damp Heat	Constant damp heat: +40°C, 95%RH
Vibration	Power-on status, sine vibration, 5~15Hz/displacement 1mm, 15-200Hz/1g, X/Y/Z three axes, single vibration time 7Min
Shock	Power-on status, half-sine wave/peak acceleration 10g/duration 11ms, X/Y/Z three axes, 3 times of shock on each axis
Drop	Program IV transportation drop (package drop, height 122cm, 8 corners, 6 sides, 12 edges)
Protection Grade	Protection grade of the PC IP65

* As for environment, EMC and other indices, the Technical Agreement between the two parties shall prevail.

Ordering Information

Part No.	Model	Description
0010-123231	JNB-1502P	i7-7820EQ 3.0GHz/8GB memory/128GB SSD/15.6" sunlight readable screen/wireless/bluetooth/optical drive/6600mAh battery/plastic keyboard/180W aviation plug adapter

Note: The final interpretation rights for product specifications, ordering information, etc. belong to EVOC Intelligent Technology Co., Ltd.

JEC-1502

15" Flip-down Cover Portable Rugged Computer

JEC-1502 is a portable rugged computer developed for both vehicular and field work environments. The product contains a dedicated rugged motherboard and has a high-quality aluminum alloy structure. It can be used in information system field combat environments, and information acquisition and processing terminals, supports insertion and connection with expansion function boards, and can meet the requirements of information acquisition and processing, general text processing, graphic display and processing, network information processing, and other applications.



Product Features



Flip-down cover design



Rugged, elegant and portable



Optional all or partially aviation plug



Modular design



Multiple expansion slots to facilitate expansion

Product Dimensions Drawing

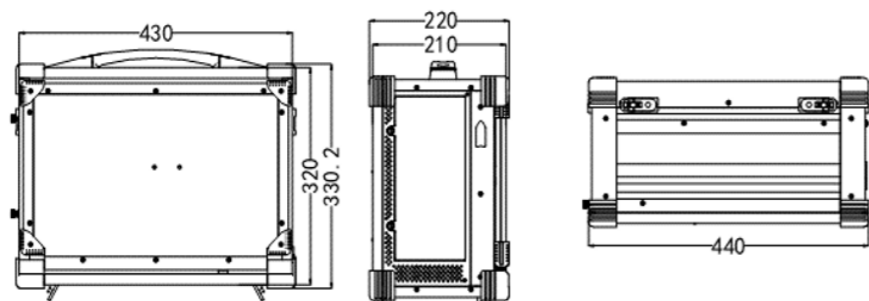

Please refer to the user manual to check detailed specifications and dimension. (Unit: MM)

Product Specifications

Item	Description
Processor	JEC-1502-04: Intel® Core™ I7-6700 3.4GHz(up to 4.0GHz) quad-core 8-thread
Display	15"LCD wide-temperature screen, resolution 1024×768
Memory	JEC-1502-04: 2 x 288Pin DDR4 memory slot, the PC supporting up to 32GB, standard configuration 8GB
Storage	JEC-1502-04: 2 x 2.5" SATA port, standard configuration 512GB SSD
Optical Drive	JEC-1502-04: built-in 1 x DVD burner drive
IO Ports	JEC-1502-04: 1 x VGA port 1 x DP port 2 x 10/100/1000M self-adaptive LAN port, supporting remote wake-up function 2 x RS-232/422/485, COM1 supporting wake-up 2 x USB3.0 2 x USB2.0 1 x PS/2 port 1 x AC power input connector
Expansion	JEC-1502-04: 4*PCI, 1*PCIe×16, 1*PCIe×4
Keyboard/mouse	86-key water-proof plastic keyboard, with left/right-key water-proof touch pad mouse
Audio Function	HD AUDIO audio output; MIC, LINE-OUT JEC-1502-04: HD AUDIO audio output; 1 x MIC port, 1 x LINE-IN port, 1 x LINE-OUT port
Power Supply	JEC-1502-04: 220VAC/350W power supply
Dimensions	About 430mm×320mm×210mm (W×H×D)(excluding corner protectors and handle), allowable error ±1mm
Weight	≤15kg
Operating Systems	Supports Windows7, etc.
Color	JEC-1502-04: diamond black
Temperature	JEC-1502-04: Working temperature: - 10°C~ + 50°C Storage temperature: - 40°C~ + 60°C
Damp Heat	Constant damp heat: +40°C, 95%RH
Vibration	Power-on status, sine vibration, 5~15Hz/displacement 1mm, 15-200Hz/1g, X/Y/Z three axes, single vibration time 7Min
Shock	Power-on status, half-sine wave/peak acceleration 20g/duration 11ms, X/Y/Z three axes, 3 times of shock on each axis
Protection Grade	Display and keyboard meet the requirements of IP54

* As for environment, EMC and other indices, the Technical Agreement between the two parties shall prevail.

Ordering Information

Part No.	Model	Description
0010-122851	JEC-1502-04 (standard port)	15" flip-down cover/I7-6700 3.4GHz/8G memory/512G SSD/4*PCI/1*PCIe×16/1*PCIe×4/optical drive/350W power supply/diamond black

Note: The final interpretation rights for product specifications, ordering information, etc. belong to EVOC Intelligent Technology Co., Ltd.

JPC-8203B Rack Mount Rugged Vehicle Mount Computer

JPC-8203B is a 2U 19" rack mount rugged computer. It adopts main board+expansion board design solution, and the modules and boards are connected by highly reliable connectors. Its chassis is made of high-quality stainless steel plates and Al-alloy sheet metal parts, and the complete PC has excellent overall heat dissipation, anti-vibration and EMC performance, and three-proofing capabilities. The product can be used in application environments characterized by strong vibration, wide temperature, low air pressure, damp heat, salt fog, mold, etc., and can meet the requirements of people's air defense emergency response, vehicle, ship and other applications.



Product Features



Vehicle mount basic rugged computer



Onboard CPU, memory, expansion card rugged design

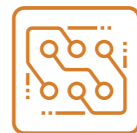

CPCI connector used inside the PC, to ensure reliable connection



Complete I/O ports

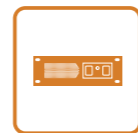

Hard Al-alloy panel



Conformal-coating processing for the PC

Product Dimensions Drawing

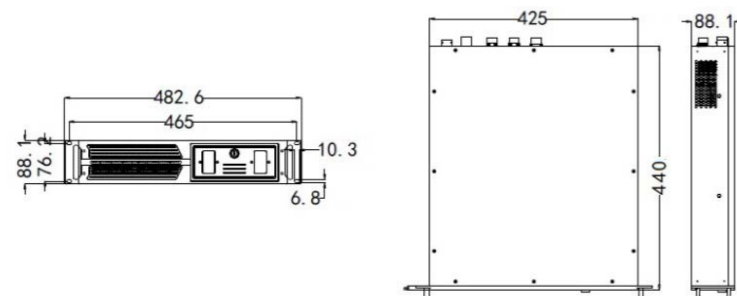

Please refer to the user manual to check detailed specifications and dimension. (Unit: MM)

Product Specifications

Item	Description	
System Configuration	Processor	Intel® Core™ i7-4700EQ/2.4GHz/3M Cache quad-core 8-thread
	Chipset	Intel® QM87 chipset
	Memory	Onboard 4GB DDR3L 1333MHz memory, SO-DIMM expansion up to 8GB, the system supporting up to 12GB
Storage Port	SATA	2 x 2.5" SATA hard disk bay(no hard disk as default configuration)
I/O Ports	USB	Front: 2 x USB2.0 port; Rear: 5 x USB2.0 port;
	COM	2 x COM port, supporting RS232/485/422 mode switch, among them: JPC-8203B-04: 2 x COM aviation plug output; JPC-8203B-05: 2 x COM port standard port output;
	LAN	2 x 10/100/1000Mbps LAN port: JPC-8203B-04: 2 x aviation plug output; JPC-8203B-05: 2 x standard RJ45 port out;
	Display	Supports MXM graphics card input JPC-8203B-04: 1 x aviation plug output; JPC-8203B-05: 1 x standard VGA port, 1 x standard DVI-D port;
Audio		JPC-8203B-04: no audio port; can be lead out via custom; JPC-8203B-05: standard line out, MIC port;
Expansion Ports	PCIe	1 x PCIe×16,PCIe×8 signal output, supporting height 113mm; length 182mm; compatible with PCIe2.0 standard
	PCI	2 x PCI output, supporting height 113mm; length 182mm; compatible with PCI2.3
Mechanical Performance	Anti-vibration	5~19Hz/1mm, 19~200Hz/1.5g, three axes, 30 minutes for each axis, the product in working state during the test;
	Anti-shock	20g/11ms, half-sine wave, 3 times of shock for each of the three axes, the product working in the test
	Transportation	Supports third-class highway transportation for 600km, and supports no loose part, normal working
	Reliability	MTBF≥100000H
Maintainability		MTTR≤0.5H
EMC		Complies with GB9254 class B; JPC-8203B-04 complies with seven requirements of GJB151B-2013
Working Temperature		-25°C~+55°C (wide temperature -40°C~+70°C optional)
Storage Environment		-40°C~+70°C
Color		Military vehicle green
Damp Heat		40°C 95%RH
Power Supply		220VAC aviation plug input
Operating Systems		Win XP, Win7, LINUX, KylinOS, etc.
Dimensions(W×H×D)		425mm×88.1mm×440mm

* As for environment, EMC and other indices, the Technical Agreement between the two parties shall prevail.

Ordering Information

Part No.	Model	Description
0010-123391	JPC-8203B-04	2U rugged computer/Intel® QM87 chipset/ i7-4700EQ 2.4GHz /onboard 4GB DDR3L(optional expansion to 8GB)/ front panel 2 x USB2.0 standard/rear panel 5xUSB2.0/1xVGA/2xCOM /2xLAN/PCI-E*16/2 x PCI /200W ATX power supply (aviation plug)
0010-123401	JPC-8203B-05	2U rugged computer/Intel® QM87 chipset/ i7-4700EQ 2.4GHz /onboard 4GB DDR3L(optional expansion to 8GB)/front panel 2 x USB2.0 standard/5xUSB2.0/1xVGA/ 1xDVI/2xCOM /2xLAN/PCI-E*16/2 x PCI /200W ATX power supply

Note: The final interpretation rights for product specifications, ordering information, etc. belong to EVOC Intelligent Technology Co., Ltd.

JPD-0701

7" Rugged Tablet PC

JPD-0701 is a 7" rugged tablet PC designed and developed based on the ARM platform. It contains a 6-core RK3399 domestic CPU. The PC serves as an information terminal to undertake multiple application tasks such as communication, surveying and mapping, data collection and processing, and is suitable for being used in various extremely harsh and hostile environments.

The product has ruggedness, high stability, high reliability, water resistance, dust resistance, vibration resistance, drop resistance, wide temperature and other features. As the product has undergone strict industry standard testing, it can meet the requirements of special industries for special work and tasks in harsh environments.



Product Features

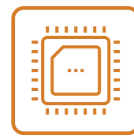

Domestic RK3399 six-core processors, low power consumption



Optional BD port, 5G port, RFID port, NFC port



7" high-brightness touch screen



Aviation plug port design for the whole PC body

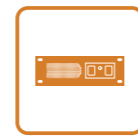

Supports docking station, expansion to charging ports and standard LAN ports



Portability and convenient use

Product Dimensions Drawing

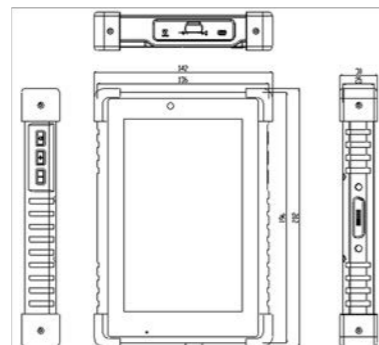

Please refer to the user manual to check detailed specifications and dimension. (Unit: MM)

Product Specifications

Item	Description
Processor	Rockchip RK3399 1.8 GHz big.LITTLE architecture, dual-core Cortex-A72 (big core)+quad-core Cortex-A53 (little core) structure
Display	7"WXGA LCD screen, resolution 1280×800, sunlight readable
Touch Screen	Multi point capacitive touch screen, multi-touch
Memory	4GB RAM
Storage	64GB ROM
IO Ports	1 x COM port(aviation plug) 2 x USB2.0 port(aviation plug) 1 x power supply connector(aviation plug)
Docking Station	1 x power supply port(aviation plug) 1 x Gigabit LAN port(standard RJ45)
Keyboard	Switch button, sound volume +, sound volume -
Expansion	BD module, 5G module, RFID module, NFC module (all required custom)
Audio/Video	Built-in 1 x speaker, built-in 1 x MIC
Camera	1 x 5 megapixels camera at front 1 x 13 megapixels camera at rear (supporting flash lamp)
Fingerprint Recognition	Supports multi-user fingerprint storage and recognition, image pixel 256*288
Power Adapter	AC adapter: AC100-240V, DC12V@60W, aviation plug
Battery	Built-in 4900mAh non-detachable lithium battery
Dimensions	About 196mm(L)×136mm(W)×25mm(T)(excluding corner protectors), allowable error ±1mm
Weight	≤0.7Kg(excluding power adapter, docking station and accessories)
Operating Systems	Supports Android7.0
Temperature	Working temperature: - 20°C~ + 55°C Storage temperature: - 40°C~ + 70°C
Damp Heat	Alternating damp heat: +30°C~+60°C, 95%RH
Vibration	Power-on status, sine vibration, 5~15Hz/displacement 1mm, 15-200Hz/1g, X/Y/Z three axes, single vibration time 7Min
Shock	Program I functional shock (power-on state, final-peak saw-tooth wave/20g/11ms, three axes and six directions)
Drop	Program IV transportation drop (package drop, height 122cm, 8 corners, 6 sides and 12 edges)
Protection Grade	IP64

* As for environment, EMC and other indices, the Technical Agreement between the two parties shall prevail.

Ordering Information

Part No.	Model	Description
0020-064681	JPD-0701	RK3399 1.8GHz/4GB memory/64GB storage/2*USB/1*COM port/fingerprint recognition/4900mAh battery/ front and rear cameras/60W aviation plug adapter/iron-gray
0020-064691	JPD-0701-01	RK3399 1.8GHz/4GB memory/64GB storage/2*USB/1*COM port/fingerprint recognition/4900mAh battery/ front and rear cameras/60W aviation plug adapter/diamond black

Note: The final interpretation rights for product specifications, ordering information, etc. belong to EVOC Intelligent Technology Co., Ltd.

JPD-1003

10.1" Rugged Tablet PC

JPD-1003 is a rugged, durable, light and portable tablet PC having multiple data acquisition functions, and designed specifically for harsh environments and outdoor workers. Integrating various anti-harsh-environment characteristics, the product has ruggedness, high stability, high reliability, water resistance, dust resistance, vibration resistance, drop resistance and other features. Its ruggedness index meets multiple industry standards, and can meet the requirements of mobile work in harsh outdoor environments. It can be used as an information terminal to undertake multiple application tasks such as communication, survey and mapping, data collection and processing, and is suitable for being used in extremely harsh environments such as outdoor and vehicular environments.



JPD-1003 is a 10.1" rugged tablet computer designed and developed based on Intel Core i7 8-Gen platform. Its processor uses i7-8665UE, quad-core 8-thread, with a clock frequency of 1.7 GHz and a maximum turbo frequency of 4.4 GHz, so the tablet PC has super computing power and higher processing performance.

Product Features



10.1" high-brightness touch screen



Intel Core 8th Gen i7 processors



Supports Win10/Kylin operating systems



Optional active stylus and hand rest on the back



Multiple ports, most of aviation plug port



Portability and convenient use

Product Dimensions Drawing

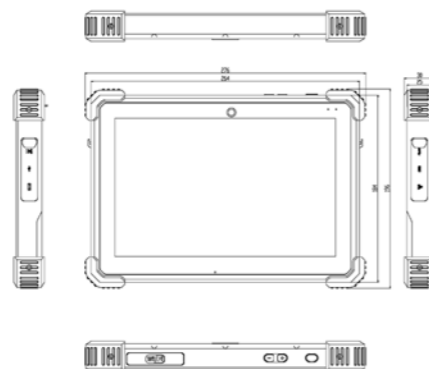

Please refer to the user manual to check detailed specifications and dimension. (Unit: MM)

Product Specifications

Item	Description
Processor	Intel® Core™ i7-8665UE quad-core 8-thread dominant frequency 1.7GHz
Display Screen	10.1"capacitive touch screen display, resolution 1280*800, screen ratio 16: 10, sunlight readable
Touch Screen	Multi-point capacitive touch screen
Memory	Onboard 8GB DDR4 memory 1 x SO-DIMM expansion memory slot, the PC supporting expansion up to 24GB
Storage	1 x MSATA port, standard configuration 128GB SSD
IO Ports	1 x HDMI(standard) 1 x USB3.0 port(standard) 1 x USB2.0 port(aviation plug) 1 x COM port(aviation plug) 1 x Gigabit LAN port(aviation plug) 1 x power supply connector(aviation plug)
Button	On/Off button, sound volume+, sound volume -
Communication	1 x M.2 Key-E socket, wireless+bluetooth module customizable (optional)
Audio/Video	1 x speaker on the PC body, 1 x MIC on the PC body
Camera	1 x 12 megapixels camera at rear(with flash lamp)
Indicator	Power indicator, battery charging/discharging indicators
Power Adapter	AC power adapter: AC100-240V, DC19V@180W, aviation plug
Battery	2 x 4400mAh lithium battery
Dimensions	About 264mm(L)×184mm(W)×25mm(T)(excluding corner protectors), allowable error ±1mm
Weight	≤2.3Kg(excluding power adapter and optional accessories)
Operating Systems	Supports Windows10 64-bit/KylinOS V10 SP1 desktop version operating systems
Temperature	Working temperature: - 20°C~ + 55°C Storage temperature: - 40°C~ + 70°C
Damp Heat	Alternating damp heat: +30°C~+60°C, 95%RH
Vibration	Power-on status, sine vibration, frequency 50-500Hz/acceleration 4.2g, X/Y/Z three axes, single vibration time 7Min
Shock	Program I functional shock (power-on state, final-peak saw-tooth wave/20g/11ms, three axes and six directions)
Drop	Program IV transportation drop (package drop, height 122cm, 8 corners, 6 sides and 12 edges)
Protection Grade	IP64
Accessories	Capacitive stylus, hand rest on the back (optional)

* As for environment, EMC and other indices, the Technical Agreement between the two parties shall prevail.

Ordering Information

Part No.	Model	Description
0010-151051	JPD-1003	i7-8665UE 1.7GHz/8GB memory/128GB storage/10.1" sunlight readable screen/rear camera/2*4400mAh battery/180W aviation plug adapter
0010-152271	JPD-1003-01	i7-8665UE 1.7GHz/8GB memory/128GB storage/10.1" sunlight readable screen/rear camera/2*4400mAh battery/180W aviation plug adapter/wireless/bluetooth/capacitive stylus/hand rest on the back

Note: The final interpretation rights for product specifications, ordering information, etc. belong to EVOC Intelligent Technology Co., Ltd.

CPC-3414B

4U 14-slot 19" Rack Mount CompactPCI System Platform

CPC-3414B is a 4U 14-slot 19" standard rack mount CompactPCI chassis. The chassis provides 1 x system slot and 13 x expansion slot, and supports insertion of cards at both front and rear. It has a pluggable fan module, and deploys heat dissipation design by blowing air from bottom to top. A dust filter mesh is installed at each air inlet, which facilitates replacement. The product is widely used in industry computer rooms.



Product Features

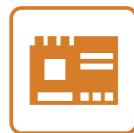

4U 14-slot 19" rack mount CompactPCI system platform

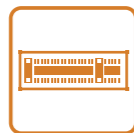

14 x vertical direction 3U CPCI slot, supporting 32bit/33MHz, and supporting rear I/O



Built-in 2 x 250W CPCI redundant power supply, AC or DC input optional



Equipped with 8 x 80mm fan, cooling air flowing from bottom to top, which ensures sufficient heat dissipation

Product Dimensions Drawing

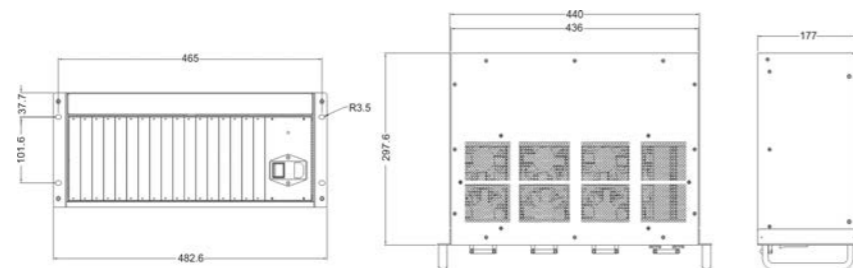

Please refer to the user manual to check detailed specifications and dimension. (Unit: MM)

Product Specifications

Item	Description
Description	Dimensions: 440mm x 177mm x 298mm (W x H x D) Material: Stainless steel metal chassis, black painting process
Backplane	Backplane (CPC-9314B) Supports 32bit/33MHz CPCI bus 14 x CompactPCI slot(1 x system slot, 13 x external slot), 2 x 3U 8HP CPCI power supply bay In the middle are bridge slot and main control slot, supporting rear IO
System Dissipation	Heat dissipation design by blowing air from bottom to top 40mm DC 12V/0.1A fan x 8
System Power Supply	1+1 3U CPCI redundant power supply, supporting AC/DC input, 100~240V AC input with overvoltage/short circuit protection circuit
Environment Specifications	Working temperature: 0°C~55°C Storage temperature: -20°C~60°C Relative humidity: 5%~90% non-condensing MTBF > 50,000 hours MTTR < 0.5 hours
Mechanical Specifications	Safety: meets basic requirements of GB4943 EMC: Radio disturbance limit complies with GB9254-1998 standard class A immunity complies with GB/T 17618-1998 standard class A Anti-vibration: 5-19Hz/1mm amplitude, 19-200Hz/1g acceleration Anti-shock: 10g acceleration, 11ms duration
Compatible Specifications	PICMG 2.0 R3.0 CompactPCI Specification PICMG 2.1 R2.0 CompactPCI Hot Swap Specification

* As for environment, EMC and other indices, the Technical Agreement between the two parties shall prevail.

Ordering Information

Part No.	Model	Description
0020-056840	CPC-3414B-01	19" 4U 14-slot CPCI chassis/3U slot/CPC-9314B backplane/bridge board/2 x 250W Power One CPCI AC power supply/4 x hot-swappable fan at the bottom
1460-037901	3U 4HP blanking panel	3U high 4HP blanking panel assembly

Note: The final interpretation rights for product specifications, ordering information, etc. belong to EVOC Intelligent Technology Co., Ltd.

CPC-8408B

4U 8-slot 19" Rack Mount CPCI Communication Computing Platform

CPC-8408B is a standard rack mount 4U 8-slot 19" CompactPCI chassis, which has 1x system slot, 7x expansion slot, supports front and rear card insertion, and complies with PICMG2.0, PICMG2.1, and PICMG2.9 specifications. It has a pluggable fan module, and deploys heat dissipation design by blowing air from right to left. A dust filter mesh is installed at each air inlet, which facilitates replacement. The product is suitable for being used in various fields such as communication, voice value-added applications, videos, vehicles, and measurement and control.



Product Features

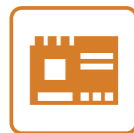

4U 8-slot 19" standard rack mount CompactPCI system platform



1 x system slot, 7 x expansion slot, compatible with 32/64bit, 33Hz supporting Rear I/O



2 x 2.5" pullable hard disk bay



1+1250W3U8HPC PCI redundant power supply, supporting AC/DC input



5 x 80mm axial fan, heat dissipation design by blowing air from right to left

Product Dimensions Drawing

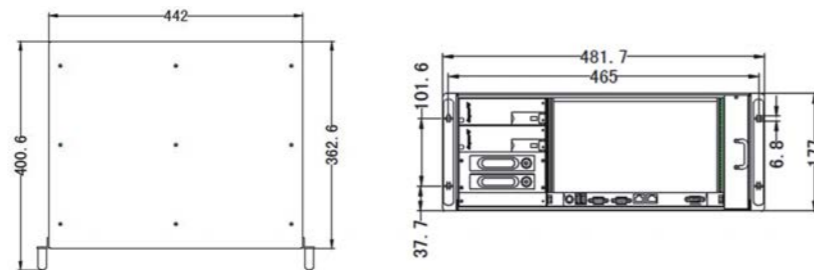

Please refer to the user manual to check detailed specifications and dimension. (Unit: MM)

Product Specifications

Item	Description
Description	Dimensions: 177mm x 481.7mm x 400.6mm (H x W x D) 6U CPCI front-insertion card (233mm x 160mm), rear-IO-insertion card (233mm x 80mm) 2 x 2.5" pullable hard disk bay, 1 x intelligent monitoring module Stainless steel metal chassis, black painting process
Backplane	Backplane CPC-9108B: 1 x system slot, 7 x expansion slot, 32/64bit, 33 MHz CompactPCI bus, supporting rear I/O 1+1 250W 3U8HP CPCI redundant power supply, supporting AC/DC inputs Compatible with PICMG2.0, PICMG2.1 specifications
System Heat Dissipation	Heat dissipation design by blowing air from right to left 5 x 80mm axial fan, 4800rpm, maximum wind speed 7.8m/s
System Power Supply	2 x 250W 3U CPCI power supply, AC or DC input optional 1+1 redundant backup, with overvoltage, overcurrent and short circuit protection circuit, and current sharing function
Environment Specifications	Working temperature: -5°C~55°C Storage temperature: -45°C~85°C Relative humidity: 5%~90% non-condensing MTBF > 50,000 hours MTTR < 0.5 hours
Mechanical Specifications	Safety: meets basic requirements of GB4943 EMC: Radio disturbance limit complies with GB9254 standard class A immunity complies with GB/T 17618 standard class A Anti-vibration: 5-17Hz/1mm amplitude, 17-200Hz/1g acceleration Anti-shock: 10g acceleration, 11ms duration
Compatible Specifications	PICMG 2.0 R3.0 CompactPCI Specification PICMG 2.1 R2.0 CompactPCI Hot Swap Specification PICMG 2.10 R1.0 CompactPCI Keying Specification PICMG 2.11 R1.0 CompactPCI Power Interface Specification

* As for environment, EMC and other indices, the Technical Agreement between the two parties shall prevail.

Ordering Information

Part No.	Model	Description
0020-057261	CPC-8408B	19" 4U 8-slot 64Bit CPCI system/CPC-9108B backplane/2 x HDD slot/2 x 250W CPCI power supply
1460-037881	6U 4HP blanking panel	6U high 4HP blanking panel assembly

Note: The final interpretation rights for product specifications, ordering information, etc. belong to EVOC Intelligent Technology Co., Ltd.

CPC-3815B

3U CompactPCI Motherboard

CPC-3815B is a standard 3U CompactPCI motherboard. The product contains Intel's next Gen low-power and high-performance Atom processor, and its graphics core integrates Intel® HD 7th Gen graphics engine, supporting DX11 and 3D output. The product has onboard 4GB DDR3L 1333/1600MT/s memory, 16G SSD storage optional, and at the same time, offers VGA, Gigabit Ethernet port, COM port, USB, SATA, and audio ports. It can also provide more IO expansion possibilities by means of PMC ports.

The main components of this product, such as processor, memory, and hard disk, are all onboard. The conduction rugged version is specifically designed for harsh military environments and has features such as ultra-low power consumption, wide temperature range, vibration resistance and shock resistance. The product is also compatible with EN50155 and is an ideal platform for high reliability rail transit applications.



Product Features

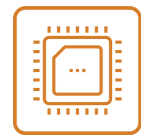

Onboard lower power processor



Can be matched with any memory



Suitable for PC fanless environment



Conduction Rugged version to meet the requirements of rugged applications



Compatible with EN50155 industry standard

Product Dimensions Drawing

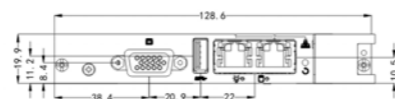
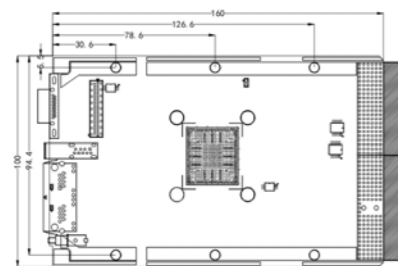

Please refer to the user manual to check detailed specifications and dimension. (Unit: MM)

Product Specifications

Item		Description
System Configuration	Processor	Intel® E3845(1.91 GHz)
	Memory	Onboard 4G DDR3 memory
Display port		Front panel: 1 x VGA Rear I/O board: 1 x VGA Dual-display out, supporting dual-VGA display
LAN		Front panel: 2 x10/100/1000M Ethernet port Rear panel: two independent 10/100/1000M Ethernet ports to rear IO board (to be switched with 2-channel LAN ports on the front panel, chosen between the two by means of BIOS)
COM port		Front panel: the front panel provides 1 x standard DB9COM port, supporting RS232/422/485 (CPC-3815B-02/03) Rear I/O board: 1 x COM (RS232/422/485)
Audio		Front panel: Mic-in/Line-out (CPC-3815B-02/03)
USB		Front panel: 1 x USB 2.0 type A, 1 x USB 3.0 type A Rear I/O board: 2 x USB2.0
Storage		Onboard 16GB SSD, 1 x SATA 2.0 (switchable between front panel and rear IO board, front panel by default)
Working Temperature/Humidity		-40°C~+60°C fanless -40°C~+85°C, to be screened, forced air cooling Relative humidity: 5%-90% non-condensing Storage temperature: -40°C~+85°C
Mechanical Specifications		Dimensions: 3U 4/8HP CompactPCI 160mm (L) × 100mm (W) Shock: 20g, 11ms Vibration (5Hz-200Hz): 1.5g (working status) 2.0g (non-working status)
Compatible Specifications		PICMG 2.0 R3.0 Compact PCI Specification
Operating Systems		Win7, Win10, VxWorks 6.9, Linux

* As for environment, EMC and other indices, the Technical Agreement between the two parties shall prevail.

Ordering Information

Part No.	Model	Description
0030-021751	CPC-3815B-01	4HP single-slot/Baytrail-I/E3845(1.91GHz)/4G DDR3/onboard 16G SSD/VGAx1/LAN x2/USB3.0 x1
0030-022011	CPC-3815B-02	8HP dual-slot/Baytrail-I/E3845(1.91GHz)/4G DDR3/VGAx1/SATA/LAN x2/COM x1/USB3.0 x1/USB2.0 x1/PS/2 KB/MS/MIC-in/Line-out
0030-021761	CPC-3815B-03	8HP dual-slot/Baytrail-I/E3845(1.91GHz)/4G DDR3/onboard 16G SSD/VGAx1/SATA/LAN x2/COM x1/USB3.0 x1/USB2.0 x1/PS/2 KB/MS/MIC-in/Line-out
0030-022021	CPC-3815B-04	8HP dual-slot/Baytrail-I/E3845(1.91GHz)/4G DDR3/VGAx1/PMC/LAN x2/USB3.0 x1
0030-022031	CPC-3815B-05	8HP dual-slot/Baytrail-I/E3845(1.91GHz)/4G DDR3/onboard 16G SSD/VGAx1/PMC/LAN x2/USB3.0 x1
0030-022041	CPC-3815B-MIL	4HP single-slot/Baytrail-I/E3845(1.91GHz)/4G DDR3/onboard 16G SSD/rear IO ports: VGAx1/SATA x1/LAN x2/COM x1/USB2.0 x2/PS/2(KB/MS)
0060-005021	CPC-RP3815B	Rear IO board: 8HP dual-slot/VGAx1/SATA x1/LAN x2/COM x1/USB2.0 x2
0030-023981	CPC-3815B-06 kit/three-proofing	8HP dual-slot/Baytrail-I/E3845(1.91GHz)/4G DDR3/onboard 16G SSD/VGAx1/SATA/LAN x2/COM x2/USB3.0 x1/USB2.0 x1/PS/2 KB/MS port

Note: The final interpretation rights for product specifications, ordering information, etc. belong to EVOC Intelligent Technology Co., Ltd.

CPC-3816B

3U CompactPCI Motherboard

CPC-3816B is a standard 3U CompactPCI motherboard. The motherboard adopts the Skylake platform CM236 chipset, onboard latest 8GB DDR4 2133MT/s memory, and Intel's 6th Gen high-performance processor. Its graphics core integrates Intel® HD Graphics engine, supporting DX11 and 3D output. It has multiple IO ports, including 16G SSD onboard storage, 2 x VGA port, 1 x DP display port, 2 x USB3.0/USB2.0 port, 2 x USB2.0, 2 x COM port, 3 x SATA3.0 port, and 4 x Gigabit LAN port.

The main components of this product, such as processor, memory, and hard disk, adopt an onboard design, so as to ensure high reliability of the system as much as possible. It is designed for harsh environments such as aerospace, airborne and in-vehicle applications, and can meet the requirements of radar, high-speed communication, data acquisition, and other application fields. At the same time, the product design complies with the EN50155 specification. This product provides a highly reliable platform with excellent performance for rail transit applications.



Product Features

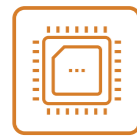

Onboard 6th Gen Skylake platform high-performance Intel® Core™ i7 processors



Onboard 8GB DDR4 memory, 16G SSD

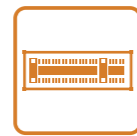

Multiple IO ports, supporting multi-display function



Conduction Rugged version to meet the requirements of rugged applications



Complies with EN50155 specifications, and meets the requirements of rail transit application

Product Dimensions Drawing

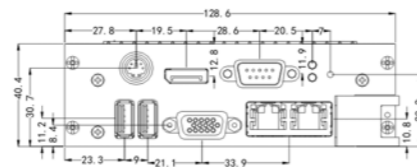
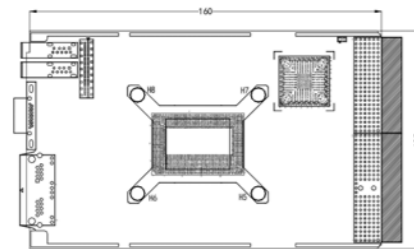

Please refer to the user manual to check detailed specifications and dimension. (Unit: MM)

Product Specifications

Item	Description	
System Configuration	Processor	Intel® Core™ i7-6822EQ processor 2.0GHz (8M Cache, up to 2.80 GHz, quad-core 8-thread), or Intel® Core™ i3-6102E 1.9GHz Processor(3M Cache dual-core 4-thread)
	Chipset	CM236 chipset
	Memory	Onboard 8G DDR4 memory, DRR4 2133 memory chip, supporting un-buffered NO ECC dual-channel function
Display Port	VGA×2 (one brought out from the backplane) , DP×1; supports triple display output under the operating system	
LAN	Front panel: 2 x Gigabit Ethernet port Rear panel: two independent 10/100/1000M Ethernet ports to the rear IO board	
IO Ports	USB: 4 x USB port, 2 at front panel, the other two brought out from the backplane COM: 1 x standard DB9COM port at front panel, supporting RS232/RS485/RS422; and 1 x DB9COM port on rear panel, supporting RS-232 Front panel PS/2 port×1	
Storage	Onboard SSD 16GB or mSATA (alternative) , simultaneously providing two-channel SATA signal brought out to rear IO board	
Working Temperature/Humidity	Working temperature: -20°C ~ +55°C Relative humidity: 5%~90% non-condensing	
Storage Environment	Temperature: -40°C~+85°C Humidity: 10%~95% (non-condensing)	
Mechanical Specifications	Dimensions: 160mm (L) × 100mm (W) × 8HP Shock: 20g, 11ms Vibration (5Hz-200Hz): 1.5g (working state) 2.0g (non-working state)	
Compatible Specifications	PICMG 2.0 R3.0 Compact PCI Specification	
Operating Systems	Windows7 32/64Bit, Windows8.1 64Bit, Linux;VxWorks	

* As for environment, EMC and other indices, the Technical Agreement between the two parties shall prevail.

Ordering Information

Part No.	Model	Description
0030-021351	CPC-3816B-01	Skylake/i7-6822EQ/8G DDR4/VGAx1/DPx1/SATA/onboard 16G SSD/LAN x2/COMx1
0030-021361	CPC-3816B-02	Skylake/i3-6102E/8G DDR4/VGAx1/DPx1/SATA /mSATAx1/LAN x2/COMx1
0030-021571	CPC-3816B-03	Skylake/i7-6822EQ/8G DDR4/VGAx1/DPx1/SATA /mSATAx1/LAN x2/COMx1
0030-021581	CPC-3816B-04	Skylake/ i3-6102E/8G DDR4/VGAx1/DPx1/SATA/onboard 16G SSD /LAN x2/COMx1
0060-005001	CPC-RP3816B	Rear IO board: VGAx1/SATA x2 /LAN x2/COM x1/USB x2

Note: The final interpretation rights for product specifications, ordering information, etc. belong to EVOC Intelligent Technology Co., Ltd.

CPC-1818

6U CompactPCI Motherboard

CPC-1818 is a standard 6U CompactPCI motherboard based on Intel® Skylake platform. The product contains Intel® 6th Gen high-performance, low-power processor, and onboard 8GB DDR4 memory. It provides 2 x VGA port, and multiple IO ports such as 3 x Gigabit LAN port, 4 x COM port and USB3.0. The product adopts Intel® Skylake-H platform, providing high-performance processing capability while reducing power consumption. The product provides multiple IO ports such as Ethernet/USB3.0/SATA3/COM ports, and can realize wider bandwidth data transmission. The product complies with PICMG 2.0 CompactPCI® specifications, and supports optional wide temperature and rugged versions. It can be used in application fields having relatively high requirements for reliability and availability, such as in-vehicle, airborne, and rail transit applications.



Product Features

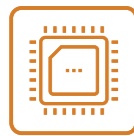

Onboard 6th Gen Skylake platform high-performance Intel® Core™ i7 processors



Onboard 8GB DDR4 memory, 16G SSD

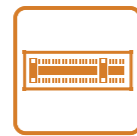

Multiple IO ports, supporting multi-display function



Conduction Rugged version to meet the requirements of rugged applications



Complies with EN50155 specifications, and meets the requirements of rail transit application

Product Dimensions Drawing

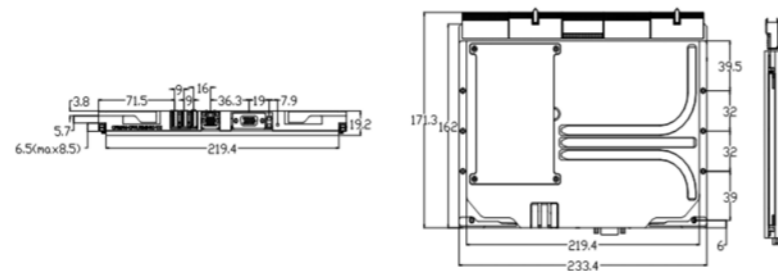

Please refer to the user manual to check detailed specifications and dimension. (Unit: MM)

Product Specifications

Item	Description	
System Configuration	Processor	Intel® Core™ i7-6822EQ processor 2.0GHz (8M Cache, up to 2.80 GHz, quad-core 8-thread)
	Chipset	Intel®Skylake-H +PCH-H CM236
	Memory	Onboard 8GB, DDR4 2133, supporting Un-buffered NO ECC dual-channel function
Display Port	2 x VGA, one brought out from the backplane, supporting dual-display output under the operating system	
LAN	Front panel: 1 x Gigabit Ethernet port Rear panel: two independent 10/100/1000M Ethernet ports to the rear IO board	
IO Ports	USB: 5 x USB port, including USB3.0*2 + USB2.0*1 at the front panel, USB2.0*2 + USB*6 brought out to the rear panel COM: 4 x DB9 at rear panel, supporting RS232/RS485/RS422COM port, 4 x RS232COM port customizable on the rear panel	
Storage	Provides 5 x SATA interface Among them, 1 x SATA hard disk interface onboard, used for 2.5" hard disk onboard; the other four SATA interfaces are brought out to rear I/O board	
Working Temperature/Humidity	Working temperature: -25°C ~ +55°C Relative humidity: 10%~90% non-condensing	
Storage Environment	Temperature: -40°C~+70°C Humidity: 10%~95% (non-condensing)	
Mechanical Specifications	Dimensions: 233.4mm (L) × 162mm (W) × 19.2mm (H) shock: 20g, 11ms Vibration (5Hz-200Hz): 1.5g (working state) 2.0g (non-working state)	
Compatible Specifications	PICMG 2.0 R3.0 Compact PCI Specification	
Operating Systems	Windows7 32/64bit, Windows8.1 64bit, Linux	

* As for environment, EMC and other indices, the Technical Agreement between the two parties shall prevail.

Note: The final interpretation rights for product specifications, ordering information, etc. belong to EVOC Intelligent Technology Co., Ltd.

CPC-1819

6U CompactPCI Motherboard

CPC-1819 is a non-standard 6U CompactPCI motherboard based on Intel® Skylake platform. It contains low-power Intel® Xeon™ E3-1505LV5 processor, CM236 chipset chip, and 16GB DDR4 memory, and supports dual VGA display output, up to 3 x Gigabit Ethernet port, onboard SSD (SATA hard disk optional), and multiple IO ports such as USB3.0, so as to meet the needs of different applications. The processor, memory, and storage media of this product adopt an onboard design. Its excellent shock resistance/vibration resistance can meet the high reliability requirements of harsh environments such as aerospace, airborne and in-vehicle applications. Its workstation level processing performance makes it ideally suitable for being used in intensive computing applications such as radar signal processing and remote sensing graphic and image analysis.

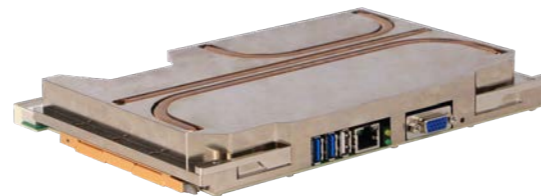

Product Features



Onboard low power Intel® Xeon™ Xeon E3-1505LV5 processor (quad-core 8-thread)



High-performance mobile workstation level processing capability, to meet the requirements of intensive computing applications

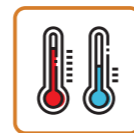

Wide temperature and rugged cold-conduction optional

Product Dimensions Drawing

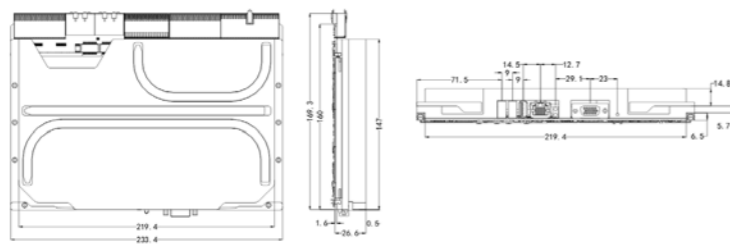

Please refer to the user manual to check detailed specifications and dimension. (Unit: MM)

Product Specifications

Item	Description	
System Configuration	Processor	Intel® Xeon® processor E3-1505L v5 2.0GHz/8MB
	Chipset	CM236 chipset
	Memory	Onboard 8GB DDR4 SDRAM 2133MHz memory, supporting dual-channel function
Display Port	Supports VGA display Onboard VGA display preferred	
LAN	3 x 10/100/1000Mbps LAN port; one on the front panel, the other two brought out to the rear IO board	
IO Ports	Provides 5 x USB port Front panel 2 x USB3.0 port, 1 x USB2.0 port the other 2 x USB2.0 port are brought out to the rear I/O board	
Storage	Provides 5 x SATA port Among them, 1 x SATA hard disk interface on board, used for 2.5" hard disk onboard; the other four SATA interfaces are brought out to	
Working Temperature/Humidity	Working temperature: -25°C ~ +55°C Relative humidity: 10%~90% (non-condensing)	
Storage Environment	Temperature: -40°C~+70°C Humidity: 10%~95% (non-condensing state)	
Mechanical Specifications	Size specifications: 6U 4/8HP CompactPCI 233.3mm x160mm x19.2mm (LxWxH) Shock: 20g, 11ms Vibration (5Hz-200Hz): 1.5g (working state) 2.0g (non-working state)	
Compatible Specifications	PICMG 2.0 R3.0 Compact PCI Specification	
Operating Systems	windows7、Server 2012	

* As for environment, EMC and other indices, the Technical Agreement between the two parties shall prevail.

Note: The final interpretation rights for product specifications, ordering information, etc. belong to EVOC Intelligent Technology Co., Ltd.

CPC-1820

6U CompactPCI Motherboard

CPC-1820 is a standard 6U CompactPCI motherboard. The motherboard adopts Skylake-H platform HM175 chipset, onboard latest 16GB DDR4 memory, and Intel's 6/7th Gen high-performance Intel® Core™ I7 series intelligent processors. Its graphics core integrates Intel® HD 530 Graphics engine, supporting DX12 and InTru 3D output. The motherboard has multiple IO ports, including 2 x Gigabit LAN port, 1 x VGA and 1 x HDMI display port, 3 x USB3.0 port, 1 x COM port, 1 x M.2 2280 NVME storage port, 1 x MSATA port, 1 x HDD light, 1 x PWR light/RST button.



The main components of this product, including processor and memory, adopt an onboard design, so as to ensure high reliability of the system to the greatest extent. The product is designed for harsh environments such as aerospace, airborne, in-vehicle, and ship-borne applications, and can meet the requirements of radar, high-speed communication, data acquisition, and other application fields.

Product Features



Onboard lower power Intel® Xeon™ Xeon E3-1505LV5 processor (quad-core 8-thread)



High-performance mobile workstation level processing capability, to meet the requirements of intensive computing applications

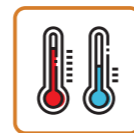

Wide temperature and rugged cold-conduction optional

Product Dimensions Drawing

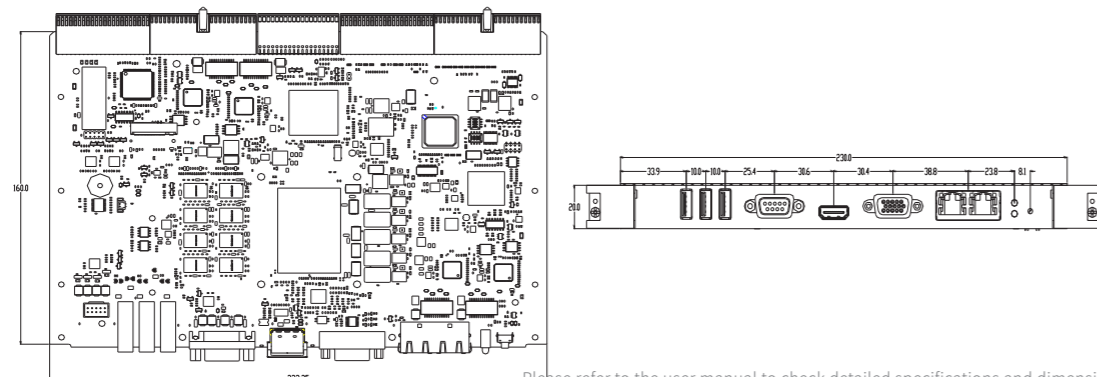

Please refer to the user manual to check detailed specifications and dimension. (Unit: MM)

Product Specifications

Item	Description	
System Configuration	Processor	Onboard i7-6822EQ 2.0GHz turbo 2.8GHz, quad-core 8-thread
	Chipset	Mobile Intel® HM175 Chipset
	Memory	Onboard 16G DDR4 memory, supporting expansion up to 32GB DDR4 memory
Display port	The platform supports VGA and HDMI dual-display Front panel VGA and HDMI: supports VGA resolution up to 1920×1080@60Hz, and supports HDMI resolution up to 4096×2304@60Hz Rear panel: 1 x VGA display port (brought out via backplane connector), supporting resolution 1920×1080@60Hz	
LAN	Front panel: provides 2 x Gigabit Ethernet port Rear IO board: supports 2-channel independent 10/100/1000M Ethernet port to rear IO board	
IO Ports	Front panel: from left to right: 3 x USB3.0 port, 1 x RS232/422/485COM port, 1 x HDMI and 1 x VGA display port, 2 x Gigabit LAN port Rear panel: 4 x USB 2.0, 2 x RS232/422/485COM port, 1 x PS2, 1 x LPT port	
Storage	1 x M.2 2280 NVME storage port and 1 x MSATA port, to facilitate expansion to SSD	
Working Temperature/Humidity	Working temperature: -10°C~55°C (-25°C~70°C wide-temperature optional)	
Storage Environment	Temperature: -40°C~+85°C Relative humidity: 5%-90% non-condensing	
Mechanical Specifications	Size specifications: 6U 4HP×233mm×160mm (H×W×D) Shock: 20g, 11ms (Working state) Vibration (5Hz-200Hz): 1.5g (Working state) Damp heat test: Under the condition of 100% relative humidity, there is no corrosion of metal parts; 40°C±2°C, under the condition of 93% relative humidity, normal storage and operation can be maintained	
Compatible Specifications	PICMG 2.0 R3.0 Compact PCI Specification	
Operating Systems	Windows7 64-bit, Windows10 64-bit, Linux and other operating systems	

Ordering Information

Part No.	Model	Description
0030-024111	CPC-1820	6U CompactPCI motherboard/i7-6822EQ 2.0GHz quad-core 8-thread/onboard 16GB DDR4/1 x M.2 2280 NVME port&1 x MSATA port/IO ports at front: 1 x VGA, 1 x HDMI, 2 x Gigabit LAN port, 1 x DB9COM port, 3 x USB3.0/1 x HDD

* As for environment, EMC and other indices, the Technical Agreement between the two parties shall prevail.

Note: The final interpretation rights for product specifications, ordering information, etc. belong to EVOC Intelligent Technology Co., Ltd.

N15-01B

Network Application Platform

The brand-new N15-01B's economical network security hardware solution is developed based on Intel® Atom 3rd Gen C3000. The product has a 1U, 19" standard rack mount chassis. It supports 1 x Mini PCI_E slot, 1 x PCI_E (signal X1, supporting peripheral devices such as encryption cards); 2 x USB port and 1 x Console port at front; onboard up to 6 x Gigabit LAN port; and 1 x ENS network expansion in the high configuration. The complete PC supports up to 14 x Gigabit LAN port.

N15-01B is mainly used in firewall, anti-virus wall, next Gen firewall, application delivery, traffic management, VPN, DNS, IDS/IPS, UTM and other scenarios.



Product Features

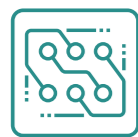

C3000 processor



2 x DDR4 memory



Onboard 6 x Gigabit electrical port+2 x Gigabit optical port+2 x 10 Gigabit optical port



1 x mini-PCIe slot



1 x SATA 3.0 interface and 1 x MSATA slot



Supports hard disk encryption and intrusion detection

Product Dimensions Drawing

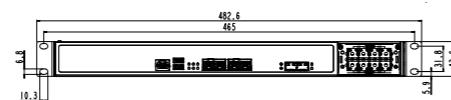
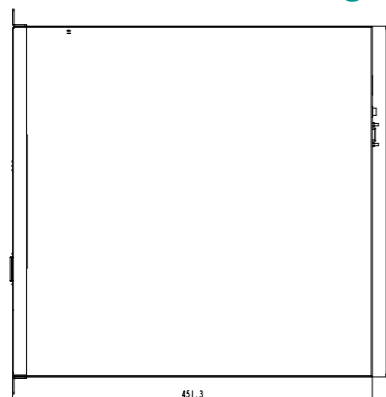

Please refer to the user manual to check detailed specifications and dimension. (Unit: MM)

Product Specifications

Item		Description
System Configuration	Processor	Intel Atom C3000 series processors in FCBGA1310 package, supporting C3000 and REFRESH all series CPUs
	Chipset	SOC
	Memory	2 x DIMM slot, supporting up to 128GB
Storage Ports	SATA	High configuration: supports 1 x SATA port
	MSATA	Low configuration: supports 1 x MSATA slot
IO Ports	USB	2 x USB3.0 (at front)
	COM	1 x RJ45 Console port (at front) , RS232 mode by default, supporting re-direction function;
Display port	1 x VGA port (optional function, which can be brought out at rear) Note: If necessary, please indicate VGA and accessory part number 1060-009761 when placing an order;	
Network Chip	Intel® I210/I211	
LAN Ports	Supports 6 x LAN port onboard; Solution 1: onboard 6 x Gigabit electrical port; Solution 2: onboard 4 x Gigabit electrical port + 2 x 10 Gigabit optical port	
GPIO	Motherboard supports 8-channel digital GPIO	
Expansion Bus	PCIE	1 x standard PCIE 8X slot (X1 signal)
	ENS	High configuration: supports 1 x ENS network card expansion slot
Matched Motherboard	NET-1832VD6N series	
Working Environment	Temperature: 0°C~40°C Humidity: 10%~95% (non-condensing)	
Storage Environment	Temperature: -20°C-70°C Humidity: 10%-95% (non-condensing state)	
Power Supply	Low configuration (no network expansion slot) : 1*60W single power supply, compatible with dual-power-supply High configuration (1 x ENS expansion slot) : 1*150W single power supply	
Dimensions (W×H×D)	440mm (W) × 44mm(H)× 450mm (D)	
Supported Operating System	Linux OS system (kernel version above 2.6). Please refer to EVOC Product Manual for details	

Ordering Information

Part No.	Model	Description
0010-176171	N15-01B-01/ C3558/8G/64G/60W single power supply	Intel C3000 platform/C3558/single memory slot/onboard 6*Gigabit electrical port/2*USB 2.0/1*console port/1*MSATA slot/no ENS expansion slot/1* PCIE X4 standard slot
0010-176181	N15-01B-02/ C3558/8G*2/1T/150W single power supply	Intel C3000 platform/C3558/dual memory slots/onboard 6*Gigabit electrical port/3 groups of bypass/2*USB 2.0/1*console port/1*MSATA slot/1*SATA interface/1*PCIE X4 standard slot/1 x ENS expansion slot (X4 signal)
0010-176201	N15-01B-04/ C3558/8G*2/1T/150W single power supply	Intel C3000 platform/C3558/dual memory slots/onboard 4*Gigabit electrical port+2*10 Gigabit optical port/2 groups of bypass/2*USB 2.0/1*console port/1*MSATA slot/1*SATA interface/1*PCIE X4 standard slot/1 x ENS expansion slot (X4 signal)

Note: The final interpretation rights for product specifications, ordering information, etc. belong to EVOC Intelligent Technology Co., Ltd.

NPC-8208

Network Application Platform

NPC-8208 is a standard 2U rack network application platform based on 6/7th Gen Intel® Xeon® E3 and Intel® Core™ i7/i5/i3 series processor. Its motherboard contains Intel® C236 chip, and its total memory capacity is up to 64GB. The platform supports single power supply, redundant power supply, or DC power supply. The platform adopts a modular design, and by configuring network modules, it can support up to 32 x high-performance Gigabit LAN port and 16 groups of Bypass.

The product can be widely used in high-end network security applications such as enterprise firewalls, enterprise antivirus walls, load balancing, and application delivery.



Product Features

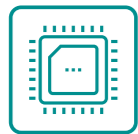

Supports multiple series processors



4 x memory slot



Multiple hard disk bay



Multiple LAN ports



Hard disk encryption



Supports rapid customization

Product Dimensions Drawing

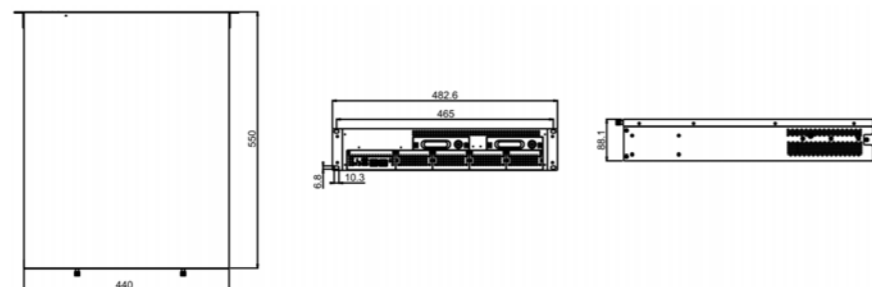

Please refer to the user manual to check detailed specifications and dimension. (Unit: MM)

Product Specifications

Item	Description	
System Configuration	Processor	Supports i3, i5, i7 Core 6/7th Gen processors in LGA1151 package, Xeon E3-1200 v5, v6 series
	Chipset	Intel C236
	Memory	4 x DDR4 memory slot, supporting un-buffered ECC memory or Non-ECC memory, the total memory capacity of the PC up to 64GB
Storage Port	SATA	3 x SATA 3.0 interface (expansion up to 5)
	Cfast	1 x Cfast slot (optional, occupying 1 x SATA3.0 resource)
IO Ports	USB	2 x USB2.0 (at front) 4 x USB pin (built-in)
	COM	1 x RJ45 Console port (at front) 1 x RS232COM port pin (built-in)
Display Port	1 x VGA port	
Network Chip	Intel®i211	
LAN Port	Onboard 1 x Gigabit LAN port	
GPIO	The motherboard supports 8 x GPIO port	
Expansion Bus	PCIE	Onboard 1 x PCIE 8X (X4 signal, sharing resource with one ENS slot)
	ENS	4 x ENS expansion slot
Matched Motherboard	NET-1825VDN(B) series	
Working Environment	Temperature: 0°C~40°C Humidity: 10%~95% (non-condensing)	
Storage Environment	Temperature: -20°C-70°C Humidity: 10%-95% (non-condensing)	
Power Supply	250W single power supply/350W ATX redundant power supply	
Dimensions (W×H×D)	440mm (W) × 88mm(H) × 550mm(D)	
Supported Operating System	Linux OS system (kernel version above 2.6)	

Ordering Information

Part No.	Model	Description
0010-086671	NPC-8208/NET-1825/ I3-6100/8GB/ 500G/250W single power supply	Standard 2U rack mount Intel C236 modular network application platform complete PC/ I3-6100 CPU/8GB DDR4 memory/500GB hard disk/onboard 1 x LAN port/4 x ENS network card expansion module bay, expandable to 32 x LAN port/1 x PCIE 8X slot (occupying one ENS slot) /standard configuration 250W single power supply
0010-086661	NPC-8208/NET-1825/ I3-6100/8GB/ 500G/350W redundant power supply	Standard 2U rack mount Intel C236 modular network application platform complete PC/I3-6100 CPU/8GB DDR4 memory/500GB hard disk/onboard 1 x LAN port/4 x ENS network card expansion module bay, expandable to 32 x LAN port/1 x PCIE 8X slot (occupying one ENS slot) /standard configuration 350W redundant power supply
0010-093131	NPC-8208/NET-1825/ I7-6700/8GB/ 500G/350W redundant power supply	Standard 2U rack mount Intel C236 modular network application platform complete PC/I7-6700 CPU/8GB DDR4 memory/500GB hard disk/onboard 1 x LAN port/4 x ENS network card expansion module bay, expandable to 32 x LAN port/1 x PCIE 8X slot (occupying one ENS slot) /standard configuration 350W redundant power supply
0010-093141	NPC-8208/NET-1825/ E3-1275V5/8GB*2PCS /500G*2PCS/350W redundant power supply	Standard 2U rack mount Intel C236 modular network application platform complete PC/ E3-1275V5/8GB*2PCSDDR4 memory/ 500GB*2PCS hard disk/supports Raid 0或Raid 1 /5 x LAN port/3 x ENS network card expansion module bay, expandable to 20 x LAN port/1 x PCIE 8X slot (occupying one ENS slot) /standard configuration 350W redundant power supply

Note: The final interpretation rights for product specifications, ordering information, etc. belong to EVOC Intelligent Technology Co., Ltd.

N35-03

Network Application Platform

N35-03 is a 1U rack mount network application platform based on Intel Coffee Lake CPU Xeon® E-series or 8/9th Gen Intel® Core® i7/i5/i3 processor. Its motherboard contains Intel® C246 chipset, and the platform adopts a standard 2U, 19" rack mount and modular structure design, which facilitates expansion to network and storage functions. N35 has onboard 2 x Gigabit electrical ports, supporting up to 8 x ENS expansion slot, and up to 66 x LAN port. The platform supports IPMI remote management and can meet the needs of various network security applications in the market.



The platform can be widely used to meet the hardware requirements of enterprises for load balancing, data audit, application delivery, online behavior management and audit, next Gen firewall, traffic management, VPN, IDS/IPS, UTM and other network security service applications.

Product Features

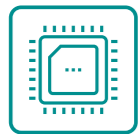

Supports multiple series processors



4 x memory slot



Supports forced Bypass switch



2 x Gigabit electrical port



Multiple expansion slots, supporting expansion to 64 x Gigabit LAN port



Supports hard disk encryption, intrusion detection and BPI port

Product Dimensions Drawing

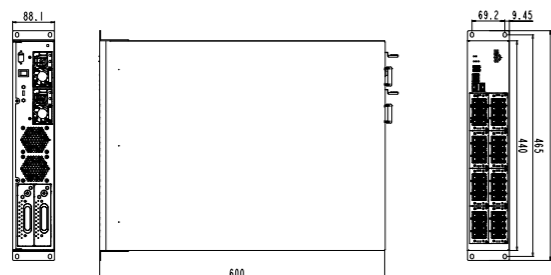

Please refer to the user manual to check detailed specifications and dimension. (Unit: MM)

Product Specifications

Item	Description	
System Configuration	Processor	LGA1151 package Intel® Coffee Lake-S, Xeon® Processor E Family, Core™ i7/i5/i3 8/9th Gen processors, Celeron, Pentium, and other processors, LGA1151 package Intel® Coffee Lake-S, Xeon® Processor E Family, Core™ i7/i5/i3 8/9th Gen processor, Celeron, Pentium and other processors
	Chipset	Intel®C246
	Memory	Provides 4 x DDR4 memory slot, supporting Un-buffered ECC and Non-memory ECC, the PC supporting up to 128GB;
Storage Ports	SATA	Onboard 2 x SATA 3.0 (one is shared with MSATA)
	MSATA	1 x MSATA slot (occupying 1 x SATA 3.0 resource)
IO Ports	USB	2 x USB3.0 port (external) , 2 x USB3.0 pin (built-in)
	COM	1 x RJ45 Console port (external) , 1 x RS-232COM port pin (built-in)
Display Port	VGA	
Network Chip	Intel®i211	
LAN Ports	Onboard 2 x Gigabit electrical port for the PC; Solution 1: 6 x Gigabit electrical port+4 x Gigabit optical port+5 x expansion port Solution 2: 6 x Gigabit electrical port+4 x Gigabit optical port+7 x expansion port Solution 3: 2 x Gigabit electrical port+8 x expansion port Note: IPMI function is optional, and when IPMI is supported, one onboard electrical port will be occupied.	
GPIO	The motherboard supports 8-channel digital GPIO port	
Expansion Bus	PCIE	1 x PCIE 8X slot (X4 signal)
	ENS	5 x ENS expansion slot (7 x optional) , optional 4/6/8 x ENS expansion slot for N35-03-09 configuration
Matched Motherboard	NET-1836VD2N series	
Working Environment	Temperature: 0°C-40°C Humidity: 10%-95% (non-condensing)	
Storage Environment	Temperature: -20°C-70°C Humidity: 10%-95% (non-condensing)	
Power Supply	Supports 350W redundant AC power supply (250W single power supply optional)	
Dimensions (W×H×D)	440mm (W) × 88mm(H)× 550mm(D)	
Supported Operating System	Linux OS system (kernel version above 2.6)	

Ordering Information

Part No.	Model	Description
0010-152681	N35-03-07/E-2278GE/8G /1T/5ENS/350W redundant	Standard 2U rack mount N35-03-07/E-2278GE/8G/6 x Gigabit electrical port(2BP)4 x Gigabit optical port/1T/5ENS/350W redundant
0010-152691	N35-03-08/I7-8700/8G /1T/7ENS/350W redundant	Standard 2U rack mount N35-03-08/I7-8700/8G/6 x Gigabit electrical port (2 groups of BYPASS) 4 x Gigabit optical port/1T/7ENS/350W redundant
0010-166291	N35-03-09/I7-8700/16G*2/1T/8ENS/350W redundant	Standard 2U rack mount N35-03-09/I7-8700/8G/6 x Gigabit electrical port (2 groups of BYPASS) 4 x Gigabit optical port/1T/8ENS/350W redundant

Note: The final interpretation rights for product specifications, ordering information, etc. belong to EVOC Intelligent Technology Co., Ltd.

SPC-8271D

19"2U Standard Rack Mount Multi-LAN-port Complete PC

SPC-8271D is a 19" 2U standard rack mount multi-LAN-port complete PC. It adopts COM board and carrier board architecture, and INTEL SkyLake-U Soc platform, wherein the carrier board is connected by means of high-speed connectors, and various functional modules are brought out via the carrier board. The front panel and chassis of the complete PC are made of sheet metal structure. The PC has excellent heat dissipation, high EMC protection grade, and excellent anti-dust performance. It fully meets the IEC 61850 international standard, and can be widely used in remote terminal management of substations, smart grid dispatch communication manager, power supervisory control and data acquisition (PSCADA) system, and subway comprehensive monitoring front-end processor (FEP).



Product Features



Meets IEC-61850 international standard



12 x LAN port, 8 x COM port



EMC performance meets the requirements of National Electric Power Level 4



Supports multiple operating systems

Product Dimensions Drawing

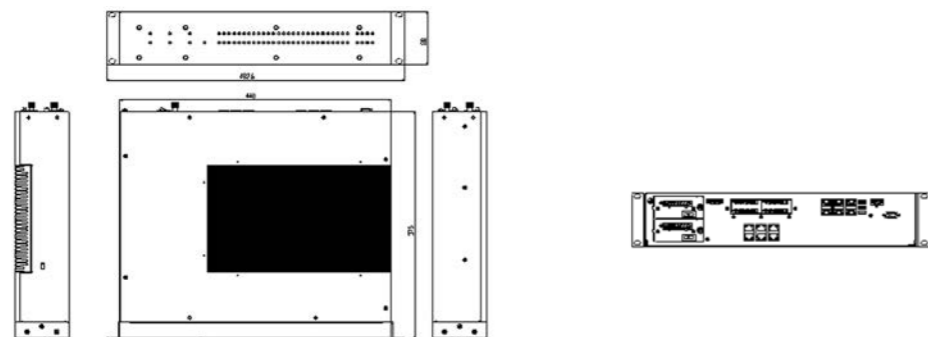

Please refer to the user manual to check detailed specifications and dimension. (Unit: MM)

Product Specifications

Item	Description	
Main Function Indices	Micro-processor	Based on Intel 3955U 2.0GHz/13-6100U 2.3GHz/15-6300U 2.4GHz/17-6600U 2.6GHz processor
	Chipset	SkyLake-U SOC
	Memory	Provides 2 x 260Pin DDR4 2133MHz So-DIMM memory slot, a single memory module supporting 16GB, the two supporting up to 32GB
	VGA	1 x VGA display port
	B Code	1 x B code time tick port
	USB	The PC provides 3 x USB2.0 port
	Network/COM Port Functions	Onboard fixed configuration: 6 x Gigabit RJ45 network port; Standard configuration of the PC: 1 x network module (6 x Gigabit RJ45 network port) Standard configuration of the PC: 1 x COM port module (8 x COM port, 2*10Pin phoenix terminal port) Note: Network module and COM port module can be configured freely
	Storage	2 x 2.5" hard disk bay
	Expansion Bus	2 x network module or COM port module expansion slot (non-standard X4) 1 x standard PCIE X1 expansion slot
	External IO Ports	1 x standard VGA display port 1 x B code time tick port, adopting 1×2Pin pitch 5.08mm phoenix terminal 12 x LAN port, including onboard 6 x LAN port, and 6 x LAN port brought out by means of modular cards (among them, network module and COM port module can be configured freely) 8 x COM port, RS-232/485 configurable, supporting at least 4-channel RS232 two devices connected in parallel, adopting 2×10Pin phoenix terminal port. (among them, COM port module and network module can be configured freely) 2-channel DO relay port, adopting 1×4Pin pitch 3.81mm phoenix terminal port Redundant power supply (optional), each power supply module providing 1 x 7Pin pitch 5.08mm phoenix terminal power input connector
Main Performance Indices	Dimensions(excluding mounting ears)	440mm (W) × 88 mm (H) × 375mm (D)
	Net Weight	About 11.25Kg (excluding weight of package and accessories)
	Color	Color of the PC: silver white
	Temperature	Working temperature: HDD: -5°C~+45°C, SSD: -25°C~+55°C; Storage temperature: -40°C~+70°C
	Humidity	Constant damp heat: 40°C, 95%RH (non-condensing)
	EMC	Complies with international standard IEC 61850"Substation Communication Network and System" Complies with national standard GB/T 15153-1"Telecontrol Equipment and Systems" Radiated disturbance: GB 9254-2008 class A Conducted disturbance: GB 9254-2008 class A GB/T 17626.2-2018 Electrostatic discharge class (IV) GB/T 17626.4-2018 Burst immunity class (IV) GB/T 17626.5-2019 Surge (shock) immunity class (IV) GB/T 17626.6-2008 Conducted immunity class (III) GB/T 17626.12-1998 Oscillatory waves immunity test class (III) GB/T 17626.3-2017 Radio frequency electromagnetic field radiation immunity class (III) GB/T 17626.9-2011 Pulse magnetic field immunity class (V) GB/T 17626.18-2017 Damped oscillatory magnetic field immunity class (V) GB/T 17626.8-2006 Power frequency magnetic field immunity class (V) GB/T 17626.11-2008 Voltage dips, short interruptions and voltage variations test (Capable of withstanding specified voltage dips 100%, duration 10ms)
	Reliability	MTBF≥30000h; MTTR≤0.5h
	Safety	Meets basic requirements of GB4943
	Mechanical Environmental Adaptability	Anti-vibration: capable of withstanding vibration response test of a severity level of Bm. (should be capable of withstanding vibration at 10m/s ² acceleration when frequency f≤9Hz, amplitude is 3mm, and f>9~200Hz); and vibration is exerted when the PC is powered off. Anti-shock: capable of withstanding shock test of a severity level of Bm, half-sine pulse duration: 11ms, peak-to-peak acceleration 10g; the test is conducted when the PC is powered off.
	Power Features	Input: AC/50Hz, 110V~220V; DC: 110V~220V single power supply, redundant power supply optional Power consumption of the PC: 27.72W (standby state) Power consumption of the PC: 34.5W (working procedure AIDA64 CPU load 100%)

Ordering Information

Part No.	Model	Description
0010-145661	SPC-8271D	2U 19" rack mount multi-LAN-port multi-COM-port complete PC/INTEL3955U2.0GHz/4G memory/128G SSD(non-wide-temperature)/12 x Gigabit LAN port/8 x isolated COM port/3 x USB2.0 at rear/1 x VGA/1 x B code/2-channel DO relay output/AC, DC110V~220V input 150W dual-power-supply/power failure alarm/neutral LOGO
0010-145671	SPC-8271D-01	2U 19" rack mount multi-LAN-port multi-COM-port complete PC/INTEL13-6100U2.3GHz/4G memory/128G SSD(wide-temperature)/6 x Gigabit LAN port/8 x isolated COM port/3 x USB2.0 at rear/1 x VGA/1 x B code/2-channel DO relay output/AC, DC110V~220V input 150W dual-power-supply/power failure alarm/neutral LOGO
0010-145681	SPC-8271D-02	2U 19" rack mount multi-LAN-port multi-COM-port complete PC/INTEL5-6300U2.3Hz/4G memory/128G SSD(non-wide-temperature)/12 x Gigabit LAN port/8 x isolated COM port/3 x USB2.0 at rear/1 x VGA/1 x B code/2-channel DO relay output/AC, DC110V~220V input 150W dual-power-supply/power failure alarm/neutral LOGO

Optional Accessories

Part No.	Model	Description
1070-002871	EF-6LAN-001SPC	6 x self-adaptive RJ45 Gigabit LAN port module
1070-002881	EF-COM-037SPC	8 x RS232/485COM port module, supporting at least 4-channel RS232 two devices connected in parallel

Note: The final interpretation rights for product specifications, ordering information, etc. belong to EVOC Intelligent Technology Co., Ltd.

ATX Motherboard ECO-1825



Ultra-strong performance Intel H610E chipset

Support 12th Gen Intel® Core i9/i7/i5/i3 series processor

Various interface

10 x USB and 6 x COM for data processing

Rich expansion

Support PCIE 5.0, HDMI 2.0 HD,
1 x 2500MBPS LAN

RAM support up to 64GB

2 x DDR4 memory slots to improve data synchronization accuracy

Intelligent & Powerful Computing New Arrival

MGP-800 GPU Computing Platform



High performance processor



Rich IO interfaces processor



Customization



Meet all application